

# 3785B

## JITTER GENERATOR & RECEIVER

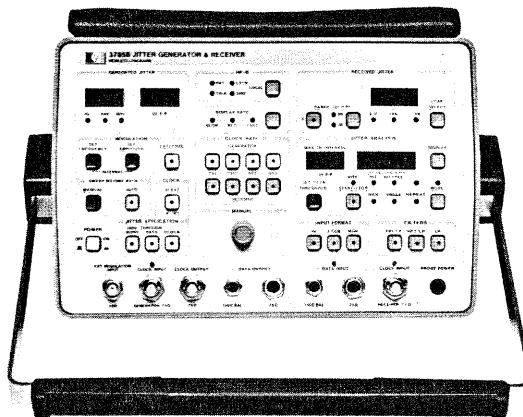



# MANUAL CHANGES

## MANUAL IDENTIFICATION

Model Number: 3785B  
Date Printed: Dec. 1981  
Part Number: 03785-90001

## OPERATING MANUAL

This supplement contains important information for correcting manual errors and for adapting the manual to instruments containing improvements made after the printing of the manual.

To use this supplement:

Make all ERRATA corrections.

Make all appropriate serial number related changes indicated in the tables below.

Serial Prefix or Number	Make Manual Changes
2212U	no change
2216U	no change
2228U	no change
2248U	no change
2402U	no change
2408U	no change
2518U	no change

Serial Prefix or Number	Make Manual Changes

\* NEW ITEM

### NOTE

Manual change supplements are revised as often as necessary to keep manuals as current and accurate as possible. Hewlett-Packard recommends that you periodically request the latest edition of the supplement. Free copies are available from all HP offices. When requesting copies quote the manual identification information from your supplement or the model number and print date from the title page of the manual.

6 May 1987

Page 1 of 3



**HEWLETT  
PACKARD**



ERRATA

\*Page 1-5, Paragraph 1-78:

Add: OPTION W30 This option is available at the time of purchase and gives 3 year Extended Hardware Support. It provides 2 additional years of return-to-HP hardware service support (for 2nd and 3rd years).

Page 1-9, Measurement Ranges for 3152K bit/s:

Change: LOG JITTER FREQUENCY "2k" to "1.2K"

JITTER MEASUREMENT Accuracy Table Note:

Add: Also typical for Receiver Internal Clock with HP1/LP selected

Page 2-8, CAUTION:

Delete: "Do not mix different batteries in the instrument"

Page 3-19, Table 3-3, RANGE (UI p-p), Parameter Range:

Add: (see Note 4)

Change: SET FREQUENCY (MODULATION), Parameter Range, "(see Note 1)" to "(see Note 1 or Note 2)"

Change: SET AMPLITUDE (MODULATION), Parameter Range, "(see Note 1)" to "(see Note 1 or Note 2)"

GENERATOR (CLOCK RATE), Parameter Range:

Add: (see Note 2 or Note 3)



ERRATA (continued)

Page 3-20, Table 3-3 RECEIVER (CLOCK RATE), Parameter Range:

Add: (see Note 4)

Table 3-3 Notes:

Add: Note 2: A wait should follow this command, the duration of which is given below.

MODULATION = INTERNAL

Modulation Frequency  $\geq 10$ Hz, wait 1 second, 4 secs for amplitude exceeding 8UI p-p.

Modulation Frequency  $\leq 10$ Hz, wait 5 seconds, 20 secs for amplitude exceeding 8UI p-p.

Note 3: A wait should follow this command, the duration of which is given below.

MODULATION = EXTERNAL

Display Rate (FAST),	wait 1 second
(MEDIUM),	wait 3 seconds
(SLOW),	wait 30 seconds

Note 4: If during the process of acquiring lock any of the following parameters change, a wait of 15 seconds is advised following the acquisition of lock before receiver measurements are taken.

- 1) RECEIVER CLOCK RATE
- 2) RECEIVER RANGE
- 3) Received Clock Rate

Page 3-21, Table 3-4, CURRENT ANSWER Parameter Range n=3:

Change: "(see Notes 1 and 2)" to "(see Notes 1, 2 and 3)".

Page 3-21, Table 3-4, Notes:

Add: Note 3. Reading of QABIT4 is advised before and after CA3 to ensure validity of result.

Page 3-27, Table 3-11:

Change: Generator SET FREQUENCY (Default Value) "1kHz" to "100Hz"

Delete: "TERM/MON" and "TERM"







**HEWLETT  
PACKARD**

## **OPERATING MANUAL**

# **3785 B**

## **JITTER GENERATOR & RECEIVER (Including Options 001, 061 and 062)**

### **SERIAL NUMBERS**

This manual applies directly to instruments with serial numbers prefixed 2131U.

For additional important information about serial numbers see INSTRUMENTS COVERED BY MANUAL in Section I.

© Copyright HEWLETT-PACKARD LIMITED 1981  
SOUTH QUEENSFERRY, WEST LOTHIAN, SCOTLAND

**Manual Part Number: 03785-90001**  
**Microfiche Part Number: 03785-90026**

**Printed: December 1981**

## WARNING

*READ THE FOLLOWING NOTES BEFORE INSTALLING OR SERVICING THE INSTRUMENT.*





1. IF THIS INSTRUMENT IS TO BE ENERGIZED VIA AN AUTO-TRANSFORMER MAKE SURE THAT THE COMMON TERMINAL OF THE AUTO-TRANSFORMER IS CONNECTED TO THE NEUTRAL POLE OF THE POWER SOURCE.
2. THE INSTRUMENT MUST ONLY BE USED WITH THE MAINS CABLE PROVIDED. IF THIS IS NOT SUITABLE, CONTACT YOUR NEAREST HP SERVICE OFFICE. THE MAINS PLUG SHALL ONLY BE INSERTED IN A SOCKET OUTLET PROVIDED WITH A PROTECTIVE EARTH CONTACT. THE PROTECTIVE ACTION MUST NOT BE NEGATED BY THE USE OF AN EXTENSION CORD (POWER CABLE) WITHOUT A PROTECTIVE CONDUCTOR (GROUNDING).
3. THE SERVICE INFORMATION FOUND IN THIS MANUAL IS OFTEN USED WITH POWER SUPPLIED TO AND PROTECTIVE COVERS REMOVED FROM THE INSTRUMENT. ENERGY AVAILABLE AT MANY POINTS MAY, IF CONTACTED, RESULT IN PERSONAL INJURY.
4. BEFORE SWITCHING ON THIS INSTRUMENT:
  - (a) Make sure the instrument input voltage selector is set to the voltage of the power source.
  - (b) Ensure that all devices connected to this instrument are connected to the protective (earth) ground.
  - (c) Ensure that the line power (mains) plug is connected to a three-conductor line power outlet that has a protective (earth) ground. (Grounding one conductor of a two-conductor outlet is not sufficient).
  - (d) Check that the instrument fuse(s) is of the correct type and rating.
5. SERVICING INFORMATION:
  - (a) This manual contains information, cautions, and warnings which must be followed to ensure safe operation and to retain the instrument in safe condition. Service and adjustments should be performed only by qualified service personnel.
  - (b) Any adjustment, maintenance, and repair of the opened instrument under voltage should be avoided as much as possible and, when inevitable, should be carried out only by a skilled person who is aware of the hazard involved.
  - (c) Capacitors inside the instrument may still be charged even if the instrument has been disconnected from its source of supply.
  - (d) Whenever it is likely that the protection has been impaired, the instrument must be made inoperative and be secured against any unintended operation.

## LIST OF CONTENTS



## SECTION I GENERAL INFORMATION

Paragraph	1-1	INTRODUCTION .....	Page	1-1
	1-5	SPECIFICATIONS .....		1-1
	1-7	SAFETY CONSIDERATIONS .....		1-1
	1-10	INSTRUMENTS COVERED BY MANUAL .....		1-1
	1-15	DESCRIPTION .....		1-2
	1-27	Measurements .....		1-3
	1-31	Programmability .....		1-3
	1-33	HEWLETT-PACKARD INTERFACE BUS (HP-IB)  .....		1-3
	1-34	Compatibility .....		1-3
	1-38	Selecting the HP-IB Address .....		1-3
	1-40	HP-IB Controllers .....		1-3
	1-42	Printer .....		1-3
	1-44	Real-Time Clock .....		1-3
	1-46	DEFINITION OF TERMS .....		1-3
	1-48	Jitter .....		1-3
	1-50	Unit Intervals (UI) .....		1-4
	1-52	Jitter Measurement (Peak-to-Peak) .....		1-4
	1-54	Jitter Measurement (Positive or Negative Peak) .....		1-4
	1-56	Internal Filtering — High Pass (HP) and Low Pass (LP) .....		1-4
	1-58	Internal Jitter Tolerance Masks .....		1-4
	1-60	Jitter Hit Threshold .....		1-4
	1-62	Jitter Hit .....		1-4
	1-64	Jitter Hit Second .....		1-4
	1-66	Jitter Hit-Free Second .....		1-4
	1-68	B3ZS .....		1-4
	1-70	B6ZS .....		1-4
	1-72	AMI .....		1-5
	1-74	RZ .....		1-5
	1-76	Ternary Data .....		1-5
	1-78	OPTIONS .....		1-5
	1-83	ACCESSORIES SUPPLIED .....		1-5
	1-85	ELECTRICAL EQUIPMENT AVAILABLE .....		1-5
	1-86	HP-IB Controllers .....		1-5
	1-88	Printer .....		1-5
	1-90	BATTERY .....		1-5
Figure	1-1	3785B Jitter Generator & Receiver .....		1-0
	1-2	Serial Number Plate .....		1-1
	1-3	Jitter .....		1-3
	1-4	AMI Data/Clock .....		1-5
	1-5	RZ Data/Clock .....		1-5
Table	1-1	Specifications .....		1-6

## SECTION II INSTALLATION

Paragraph		Page
2-1	INTRODUCTION .....	2-1
2-3	INITIAL INSPECTION .....	2-1
2-5	PREPARATION FOR USE .....	2-1
2-6	Power Requirements .....	2-1 
2-8	Line Voltage Selection .....	2-1 
2-10	Power Cord .....	2-2
2-12	HP-IB Address Selection 	2-3
2-15	Interconnections .....	2-3
2-17	Mating Connectors .....	2-3
2-20	Operating Environment .....	2-5
2-22	RACK MOUNTING .....	2-5
2-25	STORAGE AND SHIPMENT .....	2-7
2-26	Environment .....	2-7
2-28	Repackaging for Shipment .....	2-7
2-32	BATTERY OPERATION .....	2-8
2-34	Battery Removal .....	2-8
2-36	Battery Installation .....	2-8
Figure		Page
2-1	Line Voltage Selection .....	2-1
2-2	Power Cable and Mains Plug Part Numbers .....	2-2
2-3	HP-IB Address and Talk Only Format Control Switches .....	2-3
2-4	Hewlett-Packard Interface Bus Connection .....	2-3
2-5	Rack Mounting .....	2-5
Table		Page
2-1	Fuses .....	2-2
2-2	Allowable HP-IB Address Codes 	2-4

## SECTION III OPERATION

Paragraph		Page
3-1	INTRODUCTION .....	3-1
3-4	POWER CONTROLS AND CONNECTORS .....	3-1
3-7	CONTROLS, CONNECTORS AND INDICATORS .....	3-2
3-8	Front-Panel Description .....	3-2
3-9	Rear-Panel Description .....	3-5
3-10	SWITCH-ON PROCEDURE .....	3-6
3-13	ERROR CODES .....	3-6
3-15	OPERATORS MAINTENANCE .....	3-7
3-17	Fuses .....	3-7 
3-19	Air Filter .....	3-7 
3-22	OPERATORS CHECKS .....	3-8
3-23	BACK-TO-BACK CHECKS .....	3-8
3-25	USING A THERMAL PRINTER .....	3-11
3-26	MULDEM MEASUREMENTS .....	3-14

	3-27	USING AN HP-IB CONTROLLER .....	3-17
	3-28	HEWLETT-PACKARD INTERFACE BUS  .....	3-18
	3-29	HP-IB MODES OF OPERATION .....	3-18
	3-31	Operation in the Talk Only Mode .....	3-18
	3-33	Operation in the Addressable Mode .....	3-18
	3-37	PRINCIPAL FEATURES OF HP-IB OPERATION .....	3-18
	3-38	IMPLEMENTATION OF HP-IB .....	3-18
	3-39	REPertoire OF REMOTE COMMANDS .....	3-18
	3-44	CONTROL FLAGS .....	3-22
	3-46	OUTPUT MESSAGES .....	3-23
	3-47	Output Buffer .....	3-23
	3-49	Repertoire of Messages .....	3-23
	3-51	SERVICE REQUESTS .....	3-24
	3-54	Repertoire of Service Requests .....	3-24
	3-56	LOCAL Push-button .....	3-25
	3-58	Internal Real-Time Clock .....	3-25
	3-62	ERROR CODES .....	3-25
	3-64	DEFINITION OF 'LEARN' TRANSFER .....	3-26
	3-67	DEFAULT VALUES .....	3-27
	3-70	USING THE HP 37201A BUS EXTENDER .....	3-27
Figure	3-1	Key to Controls, Connectors and Indicators .....	3-1
	3-2	Push-button Switch Numbering .....	3-18
Table	3-1	Error Code Description .....	3-6
	3-2	Status Indications .....	3-7
	3-3	Switch Mnemonics .....	3-19
	3-4	Interrogation Mnemonics .....	3-21
	3-5	Control Code Mnemonics .....	3-22
	3-6	Flag Description .....	3-22
	3-7	Output Messages .....	3-23
	3-8	Service Request Codes .....	3-24
	3-9	Error Code Description .....	3-25
	3-10	Response Codes .....	3-26
	3-11	Default Values .....	3-27
	3-12	Default Causes/Effects .....	3-27

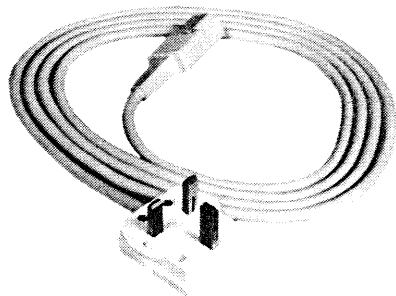
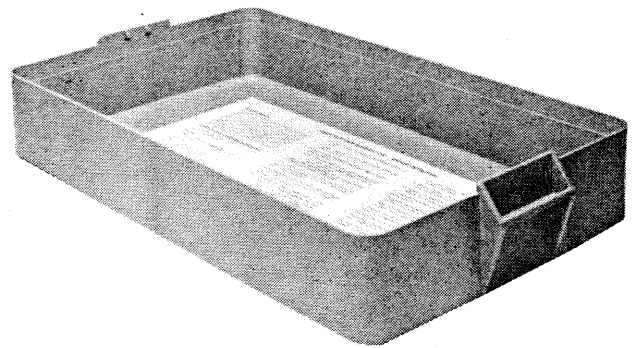

Figure 1-1 3785B Jitter Generator & Receiver

## SECTION I GENERAL INFORMATION

### 1-1 INTRODUCTION

1-2 This Operating Manual contains information required to install, check and operate the Hewlett-Packard Model 3785B Jitter Generator & Receiver. Figure 1-1 shows the 3785B and accessories supplied.

1-3 Supplied with the instrument is a separate Service Manual – for use by the maintenance engineer. This Operating Manual should be kept with the instrument for use by the operator. Additional copies of 3785B publications may be ordered through your nearest Hewlett-Packard Office.

1-4 On the title page of this manual, below the manual part number, is a Microfiche part number. This number can be used to order this manual in 4 x 6-inch microfilm transparencies, each transparency contains up to 96 photoduplicates of the manual pages. The Microfiche package also includes the latest Manual Changes supplement as well as all pertinent Service Notes.

### 1-5 SPECIFICATIONS

1-6 Instrument specifications are listed in Table 1-1. These specifications are performance standards or limits, against which the instrument is tested.

### 1-7 SAFETY CONSIDERATIONS

1-8 The HP Model 3785B Jitter Generator & Receiver is a Safety Class 1 (IEC) instrument. This instrument has been designed according to international safety standards. The instrument and manuals should be reviewed for safety markings and instructions before operation.

1-9 This manual contains information, cautions and warnings which must be followed by the user to ensure safe operation and retain the instrument in a safe condition.



Refer to Service Manual: This symbol on the instrument means the user must refer to the instrument's Service Manual to protect the instrument from damage.



Protective Earth Ground: Indicates protective earth ground terminal of the ac power source on the instrument. All exposed metal surfaces on the instrument must connect to a protective earth ground terminal.



Frame or Chassis Terminal: This symbol identifies a terminal that is normally common to all exposed metal surfaces on the instrument.

### WARNING

The **WARNING** sign denotes a hazard to the operator. It calls attention to a procedure, practice, or the like, which, if not correctly performed or adhered to, could result in injury or loss of life. Do not proceed beyond a **WARNING** sign until the indicated conditions are fully understood and met.

### CAUTION

The **CAUTION** sign denotes a hazard to the instrument. It calls attention to an operating or maintenance procedure, practice, or the like, which, if not correctly performed or adhered to, could result in damage to or destruction of part or all of the instrument. Do not proceed beyond a **CAUTION** sign until the indicated conditions are fully understood and met.

### 1-10 INSTRUMENTS COVERED BY MANUAL

1-11 Attached to the rear-panel of the instrument is a serial number plate. The serial number plate has a four-digit serial prefix, a reference letter denoting country of origin (U = United Kingdom) and a five-digit serial number. The serial prefix is the same for all identical instruments, it changes only when a change is made to the instrument. The serial number is unique to each instrument.

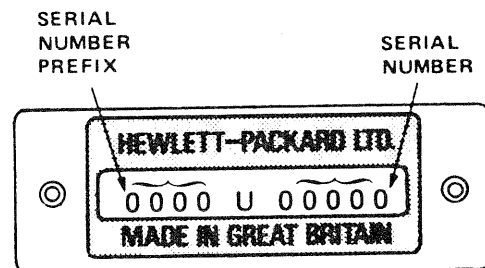

Figure 1-2 Serial Number Plate

1-12 The contents of this manual apply directly to all instruments with a serial number prefix listed under SERIAL NUMBERS on the title page. An instrument manufactured after the printing of this manual may have a serial number prefix that is not listed on the title page. This unlisted serial number prefix indicates that the instrument is different from those described in this manual. The Service Manual for this instrument is supplied with a blue Manual Changes supplement, which contains the change information that documents the differences and explains how to adapt these manuals to the newer instruments.

1-13 In addition to change information, the Manual Changes supplement may contain information for correcting errors in the manuals. To keep this manual as current and as accurate as possible, Hewlett-Packard recommends that you periodically request the latest Manual Changes supplement – quoting this manual's print date and part number (both of which appear on the title page). Complementary copies of the supplement are available from Hewlett-Packard.

1-14 For information concerning a serial number prefix which is not listed on the title page or in a Manual Changes supplement contact your nearest Hewlett-Packard Office.

## 1-15 DESCRIPTION

1-16 The HP Model 3785B Jitter Generator & Receiver is a dedicated jitter measurement system for testing and evaluating the performance of the BELL digital transmission terminal and link equipment up to and including the DS-3 level (44736kb/s) in the digital hierarchy.

1-17 The instrument is microprocessor based and HP-IB\* compatible thus allowing operational simplicity and measurement flexibility. (\*HP-IB – Hewlett-Packard Interface Bus – is Hewlett-Packard's implementation of IEEE Standard 488-1978.)

1-18 The 3785B may be used to phase-modulate either an internally-generated clock or an externally applied clock (at a nominal digital hierarchy bit rate), or an externally applied data stream. Sinusoidal modulation is provided by an internal synthesizer. The frequency and amplitude of this synthesizer can either be set manually, or automatically swept through an internally-stored CCITT (BELL) shaped mask. External modulating signals can also be applied.

1-19 The amplitude of the generated jitter (in Unit Intervals p-p) and the frequency of the internal modulation are designed to BELL requirements of CCITT Rec. 0.171. The results are displayed in digital format on the front panel.

1-20 The jitter clock output signal can be applied to an external Pattern Generator (such as HP Models 3780A, 3762A or 3781B). The CCITT standard '1000' repetitive

pattern is provided to enable muldex jitter transfer function measurements. For separate demultiplexer jitter transfer function measurements, jitter can be applied to an externally-generated data stream having the necessary framing structure, coding and voltage levels.

1-21 The 3785B Jitter Generator & Receiver can perform six types of measurement:

1. Absolute jitter amplitude (in UI p-p).
2. Jitter peak – positive or negative.
3. Jitter hit count. *The number of times the received jitter exceeds a user-defined hit threshold.*
4. Jitter hit seconds count. *The number of seconds in which one or more jitter hits occur.*
5. Jitter hit-free seconds count. *The number of seconds which are free of jitter hits.*
6. Maximum absolute jitter amplitude (in UI p-p). *Maximum amplitude achieved during the jitter analysis gating period.*

1-22 The 3785B simultaneously measures all six and displays the result selected by the DISPLAY and PEAK SELECT push-buttons. In addition, the 3785B has an internally-generated timer and real-time clock. This allows measurement of jitter distribution against time and the result recorded, via the HP-IB, on a Printer (eg, HP 5150A Option 001).

1-23 Measurements can be made on clock or data input signals either with or without internal filtering. The 3785B contains two high-pass and one low-pass filters (each filter conforming to CCITT/BELL specifications) for each of the clock rates. In addition, external filters may be connected between the demodulated jitter output and the measurement input.

1-24 The demodulated jitter output signal can also be used either with an external RMS Voltmeter (eg HP 3400A, to measure jitter amplitude) or an external Spectrum Analyzer (eg HP 3580A, to display the jitter spectrum).

1-25 The clock reference for jitter measurements can either be derived internally (from the applied data or clock signals, via a narrow-band phase-locked loop) or externally (from an applied reference).

1-26 The 3785B can also make either in-service or out-of-service measurements. The monitor facility has additional built-in gain to compensate for the flat loss at the monitor points, when making in-service measurements.



## 1-27 Measurements

1-28 The jitter receiver and built-in high and low-pass filters are utilized when making maximum p-p jitter output and tributary output jitter measurements. Normally these measurements are made out-of-service but can be made in-service (using a Pattern Generator to generate a PRBS test pattern – as specified by BELL). When making jitter tolerance measurements, the internal CCITT/BELL mask is automatically swept by a transient-free signal – thus simplifying the detection of system errors due to jitter.

1-29 The jitter transfer function (measured wideband) can be calculated from the ratio of *receiver jitter measurement display to generator jitter display* for either the internally-generated '1000' word pattern or any externally-generated pattern.

1-30 Jitter analysis is an in-service measurement. It allows detailed information on jitter behaviour to be easily obtained, especially when used with the HP-IB 'Talk Only' mode for recording results.

## 1-31 Programmability

1-32 The 3785B Jitter Generator & Receiver is completely programmable via the Hewlett-Packard Interface Bus (HP-IB). This, coupled with the diversity of measurements the Jitter Generator and Receiver can perform, makes the instrument ideal for 'systems' applications.

## 1-33 HEWLETT-PACKARD INTERFACE BUS



## 1-34 Compatibility

1-35 The extent to which the instrument is compatible with the HP-IB is given by the following list of interface functions:

SH1, AH1, T5, L4, SR1, RL1, DC1

1-36 The instrument interfaces with the HP-IB via open-collector TTL circuitry. An explanation of the implementation code may be found in IEEE Standard 488 "IEEE Standard and Digital Interface for Programmable Instrumentation", or the identical ANSI Standard MC1.1.

1-37 For more detailed information relating to programmable control of these instruments refer to HP-IB MODES OF OPERATION (Paragraph 3-29).

## 1-38 Selecting the HP-IB Address

1-39 The HP-IB ADDRESS switches are located on the rear-panel of the 3785B. The switches represent a five-digit binary number. This number represents the talk and listen

address characters which an HP-IB Controller can generate, Table 2-2 (in Section II) shows all HP-IB talk and listen addresses. Also refer to HP-IB ADDRESS SELECTION (Paragraph 2-12).

## 1-40 HP-IB Controllers

1-41 The HP-IB interface enables the 3785B to be used with any HP-IB compatible Computing Controller or Computer for automatic 'systems' applications.

## 1-42 Printer

1-43 An HP-IB compatible Printer may be connected to the 3785B for either the 'Talk Only' or 'Addressable' modes.

## 1-44 Real-Time Clock

1-45 The 3785B has a built-in, crystal-controlled, real-time clock. This permits peripheral devices to receive timed messages from the 3785B.

## 1-46 DEFINITION OF TERMS

1-47 The following paragraphs give brief definitions of terms which relate to the functions of the instrument and are commonly used in this manual.

## 1-48 Jitter

1-49 Jitter, or to be more exact 'Timing Jitter', is defined as short term variations of the significant instants of a digital signal from their ideal positions in time (see Figure 1-3).

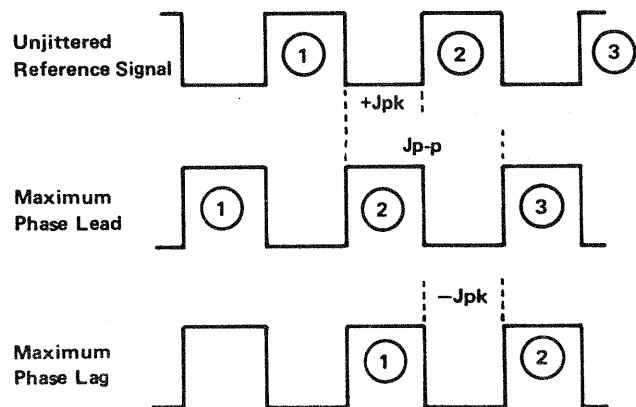

Note : The Maximum Phase Lead and Maximum Phase Lag diagrams show a jittered signal with a jitter amplitude of 1.0 UI p-p.

Figure 1-3 Jitter

**1-50 Unit Intervals (UI)**

1-51 Jitter amplitude is measured in quantities of unit intervals. A unit interval is the time allocated for the transmission of one bit of information.

$$1 \text{ UI} = \frac{1}{\text{Symbol Rate}}$$

Therefore, for the 3785B bit rates, consult the following table.

Bit Rate (kHz)	1 UI (ns)
1544	647.67
3152	317.26
6312	158.43
44736	22.35

**1-52 Jitter Measurement (Peak-to-Peak)**

1-53 Jitter measurement p-p ( J p-p) is a measurement of the maximum total excursion in the time position of a particular jittered bit relative to the time position of that particular bit whenunjittered. (See Figure 1-3.)

**1-54 Jitter Measurement (Positive or Negative Peak)**

1-55 Jitter measurement (+Jpk or -Jpk) is a measurement of the maximum excursion, either leading or lagging, in the time position of a particular jittered bit relative to its long-term mean position. (See Figure 1-3.)

**1-56 Internal Filtering – High Pass (HP) and Low Pass (LP)**

1-57 The HP1/LP, HP2/LP and LP filters (which are used to pre-shape the demodulated jitter before measurement of jitter amplitude) are those specified as High Pass Filter No.1 and High Pass Filter No.2 by the BELL requirements of CCITT Recommendation 0.171 – two for each bit rate. (See Specifications in Table 1-1 for details.)

**1-58 Internal Jitter Tolerance Masks**

1-59 The internal hard-programmed jitter tolerance masks, one for each internal clock rate, are the “Lower Limit of Maximum Tolerable Input Jitter” masks specified in CCITT

(BELL) Rec. G. Series. (See specification in Table 1-1 for details.)

**1-60 Jitter Hit Threshold**

1-61 The jitter hit threshold is the peak jitter amplitude, both positive and negative, which the user defines to allow the instrument to analyze the received jitter in terms of jitter amplitude.

**1-62 Jitter Hit**

1-63 A jitter hit is defined as an occurrence when the received jitter has exceeded the jitter hit threshold.

**1-64 Jitter Hit Second**

1-65 A jitter hit second is defined as a second (in real time) which contains one or more jitter hits.

**1-66 Jitter Hit-Free Second**

1-67 A jitter hit-free second is defined as a second (in real time) which contains zero jitter hits.

**1-68 B3ZS**

1-69 Bi-polar with 3-Zeros Substitution is a pseudo-ternary code in which a specific pattern is substituted for each block of three consecutive zeros in the data stream. The substituted code is either “00V” or “B0V” (where “V” is a bi-polar violation and “B” is an extra bi-polar mark). The choice depends on the number of marks (“n”) since the last “V” – as they must alternate in polarity in order to maintain the average dc content at zero. Hence, “00V” is used when “n” is odd and “B0V” when “n” is even.

**1-70 B6ZS**

1-71 Bi-polar with 6-Zeros Substitution – similar to B3ZS, but the substitution is made for each block of six consecutive zeros in the data stream. In this case, the substitution is always “0VB0VB” where “V” is a bi-polar violation and “B” is an extra bi-polar mark. Since two “V’s” are introduced of opposing polarity, the average dc content is maintained at zero.

## 1-72 AMI

1-73 Alternate Mark Inversion (often called "bi-polar" coding) is a form of ternary data in which data "marks" (normally representing '1's) are alternatively positive and negative. The main advantages of this basic code are that the average dc potential on the line is zero and, that this code can be used to detect if one data bit has been changed during transmission (as two consecutive bits would then have the same polarity). (See Figure 1-4.)

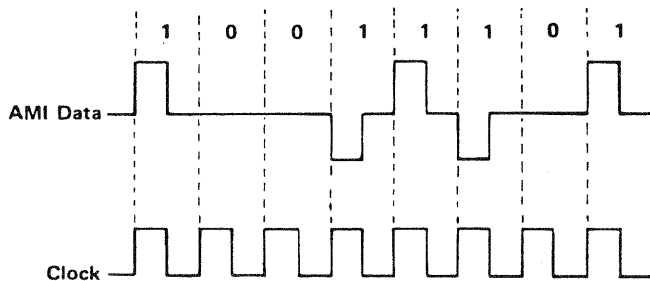

Figure 1-4 AMI Data/Clock

## 1-74 RZ

1-75 Return-to-Zero data is at the 'one' level for the duration of the clock mark and returns to 'zero' for the duration of the clock space. (See Figure 1-5.)

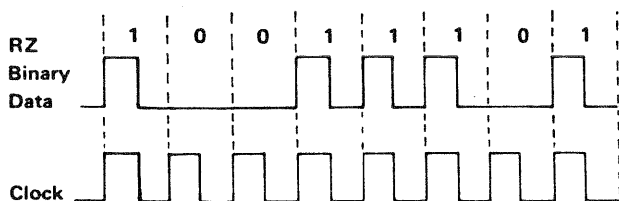

Figure 1-5 RZ Data/Clock

## 1-76 Ternary Data

1-77 "One" and "zero" are represented by a three-level signal. Ternary data is a general term which includes AMI and HDB3 codes described in this section. All of these are more correctly described as "pseudo-ternary" codes, as positive and negative marks mean the same thing.

## 1-78 OPTIONS

1-79 **Option 001** Has Bantam Jacks ( $110\Omega$  balanced) replacing the WECO 310A Jacks and WECO 447B Jacks ( $75\Omega$  unbalanced large WECO) replacing the WECO 560A Jacks on the front-panel data inputs and outputs. This option provides the 3785B with connectors to enable direct application in the Canadian digital hierarchy.

1-80 **Option 061** Rack-mounted version.

1-81 **Option 062** Rack-mounted 3785B, enabling front-panel control of rear-panel 'toggle' switches and BNC connectors.

1-82 **Option 910** extra set of manuals.

## 1-83 ACCESSORIES SUPPLIED

1-84 Figure 1-1 shows the HP Model 3785B and the accessories supplied. The accessories supplied comprise:

- Storage Cover (which houses In-lid Instructions)
- Power Cable
- Extender Board
- Manuals and Programming Notes

## 1-85 ELECTRICAL EQUIPMENT AVAILABLE

### 1-86 HP-IB Controllers

1-87 The 3785B Jitter Generator & Receiver has an HP-IB interface and can be used with any HP-IB Computing Controller or Computer for automatic 'systems' applications.

### 1-88 Printer

1-89 An HP-IB compatible Printer (eg., HP Model 5150A Option 001) can be connected to the 3785B to provide a hard-copy print-out of measurement results.

## 1-90 BATTERY

1-91 The 3785B has a built-in re-chargeable battery. This battery ensures that the front-panel set-up is not destroyed at instrument power-down. The battery is automatically recharged when the 3785B is powered from the mains supply.

### CAUTION

If the battery is left in a discharged state, permanent damage may result. The battery is NOT covered by warranty.

## Table 1-1 Specifications

Except where otherwise indicated the following parameters are warranted performance specifications. Parameters described as "typical" or "nominal" are supplemental characteristics which provide a useful indication of typical, but non-warranted, performance characteristics.

# Jitter Generator

## DATA OUTPUTS

DSX-1, DSX-1C, DSX-2, and DSX-3 compatible ternary outputs.

**DSX-1 Output** — Bell standard cross-connect waveform meeting CCITT Rec. G.703 Para. 1.

**Bit Rate:** 1544 kbit/s (tolerance — see Internal Clock).

**Format:** coded AMI (RZ).

**Impedance:** nominal 110Ω balanced.

**Connector:** WECO Type 310A.

**Amplitude:** 3V ± 0.3V pk.

**+ve/-ve Amplitude Unbalance:** less than ± 0.15V.

**Width (at half amplitude):** 324 ns ± 30 ns.

**+ve/-ve Width Unbalance:** less than ± 15 ns.

**Transition Times (10% to 90%):** < 80 ns.

**Trailing Edge Overshoot:** 10% to 30% of pulse amplitude, decaying to < 10% of base line-to-peak value in < 400 ns.

**DSX-1C Output** — Bell standard cross-connect waveform of nominally rectangular shape.

**Bit Rate:** 3152 kbit/s (tolerance — see Internal Clock).

**Width (at half amplitude):** 159 ns ± 20 ns.

**Transition Times (20% to 80%):** < 50 ns.

Other specifications same as DSX-1 Output.

**DSX-2 Output** — Bell standard cross-connect waveform meeting CCITT Rec. G.703 Para. 2.

**Bit Rate:** 6312 kbit/s (tolerance — see Internal Clock).

**Format:** coded B6ZS (AMI (RZ) for internal pattern).

**Impedance:** nominal 110Ω balanced.

**Connector:** WECO Type 310A.

**Shape:** meets Bell standard mask.

**DSX-3 Output** — Bell standard cross-connect waveform meeting CCITT Rec. G.703 Para. 4.

**Bit Rate:** 44736 kbit/s (tolerance — see Internal Clock).

**Format:** coded B3ZS.

**Impedance:** nominal 75Ω unbalanced to GND.

**Connector:** WECO Type 560A.

**Shape:** meets Bell standard mask.

## CLOCK

### Internal Clock

**Frequency:** four crystal-controlled clocks at 1544, 3152, 6312 and 44736 kHz.

**Accuracy:** setting tolerance better than ± 3 ppm at ambient temperature.

**Stability:** typically better than ± 12 ppm, 0° to 55°C; typically better than ± 5 ppm/year ageing.

### External Clock

**Frequency:** at internal rates ± 10%, nominal.

**Impedance:** nominal 75Ω unbalanced.

**Connector:** BNC.

**Termination:** GND.

**Triggering:** 8 ns min pulse width.

**Sensitivity:** better than 500 mV p-p.

**Amplitude:** 5V p-p max within limits of ± 5V.

**Indicator:** LED illuminated if clock transitions present.

### Jittered Clock Output

**Source:** internal or external clock.

**Format:** square wave 50 ± 6% duty cycle.

**Impedance:** nominal 75Ω unbalanced.

**Connector:** BNC.

**Amplitude:** nominal TTL levels (DS-1, DS-1C or DS-2), nominal ECL levels (DS-3); automatically selected.

**External Load:** 75Ω into -2V, dc coupled for ECL levels.

**Intrinsic Jitter (as measured on RANGE 1 of Receiver and HP/LP selected):** typically 0.02 UI p-p with modulator switched on.

### Reference (Unjittered) Clock Monitor Output (rear panel)

**Source:** internal or external clock.

**Format:** continuous.

**Impedance:** nominal low, unbalanced to GND.

**Connector:** BNC.

**Amplitude:** nominal ECL levels.

**External Load:** 50Ω into -2V, dc coupled; 50Ω into GND, ac coupled.

**Protection:** 100mA fuse.

**Note:** not available in the THROUGH DATA mode.

## JITTER MODULATION

### Jitter Application

Jitter can be applied to only one of the following:

1. any one of four generator internal clocks.
2. any external clock in accordance with the EXTERNAL CLOCK INPUT specification.
3. any data stream presented to the RECEIVER DATA INPUT (consistent with the RECEIVER DATA INPUT specification).
4. an internally generated 1000 word encoded in the appropriate interface code AMI, B6ZS or B3ZS.

### Internal Modulation

Peak-peak jitter amplitudes and modulating frequencies in accordance with CCITT Recommendation 0.171 Table 2 (shown by ●●●● below) and DS-3 (up to 1.12 MHz).

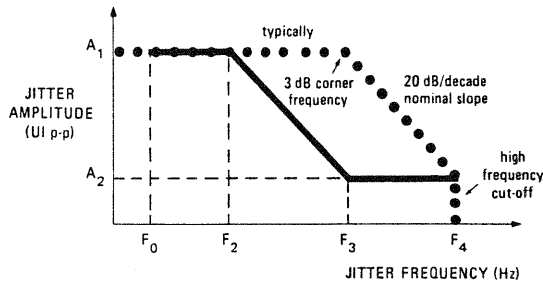

Nominal Bit Rate (kbit/s)	DS-1	DS-1C	DS-2	DS-3
A <sub>1</sub> (UI p-p)	10.0	10.0	10.0	20.0
A <sub>2</sub> (UI p-p)	0.5	—	0.5	0.5
F <sub>0</sub> (Hz)	2	—	2	2
F <sub>2</sub> (kHz)	0.2	—	1.6	3.2
F <sub>3</sub> (kHz)	4	—	32	100
F <sub>4</sub> (kHz)	40	—	160	1120
Corner Freq (kHz) typ.	10	20	40	100
Cut-off freq (kHz) typ.	77	157	316	1120

**Maximum Jitter Amplitude:** 10.10 UI p-p DS-1, DS-1C, DS-2 applied to clock or data and 20.20 UI p-p applied to clock or internal 1000 word or 14.0 UI p-p applied to through data for DS-3 (as indicated on Generator display).

**Minimum Internal Modulating Frequency:** 1 Hz.

**Distortion (at 1 kHz):** typically better than 30 dB (measured at the RECEIVER DEMODULATED OUTPUT for a jitter amplitude of 5.0 UI p-p).

### External Modulation Input

**Frequency Range:** meets CCITT Rec. 0.171 Table 2 for sinusoidal modulation and typically dc to 5% of the bit rate for DS-1, DS-1C or DS-2 and dc to 2.5% of the bit rate for DS-3.

**Impedance:** nominal 50Ω unbalanced to GND.

**Connector:** BNC.

**Sensitivity:** nominal 10 UI/V, DS-1, DS-1C, DS-2 (p-p figures at 5 Hz) nominal 20 UI/V, DS-3 (p-p figures at 5 Hz).

**Flatness:** nominal ± 0.3 dB (dc to 3 kHz).

**Maximum Input Voltage:** 1.2V p-p.

**Maximum Jitter Amplitude:** 10.10 UI p-p (DS-1, DS-1C, DS-2) applied to clock or data and 20.20 UI p-p applied to clock or internal 1000 word or 14.0 UI p-p applied to through data for DS-3 (as indicated on Generator display).

### Display Accuracy

**Amplitude:**

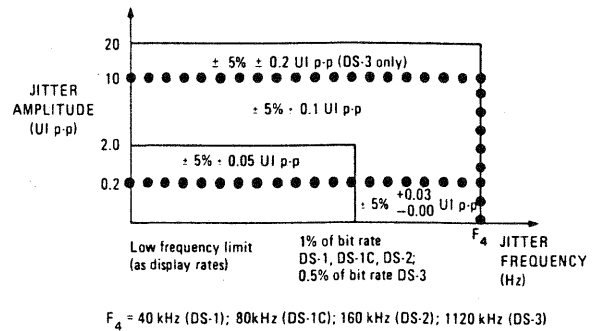

### Display Rates Valid for Measurements on Jitter Frequencies:

FAST > 10 Hz

MED > 1 Hz

SLOW > 0.1 Hz

**Note:** for internal modulation, the display rate automatically changes from Fast to Med for jitter modulating frequencies ≤ 10 Hz.

**Frequency:** ± 0.5%.

### Internal Jitter Tolerance Masks

7 hard-programmed jitter masks are provided, two for each internal clock rate, except DS-1.

The masks can be swept transient-free, manually or automatically, and their p-p jitter amplitudes and modulating frequencies are in accordance with the various CCITT G.700 Series Recommendations.

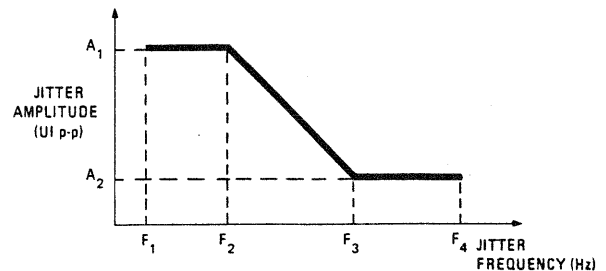

Nominal Bit Rate (kbit/s)	Multiplex or Line System Test (Generator Clock ≤ Receiver Clock)			
	DS-1	DS-1C	DS-2	DS-3
A <sub>1</sub> (UI p-p)	2.0	2.0	2.0	2.0
A <sub>2</sub> (UI p-p)	0.05	0.05	0.05	0.05
F <sub>1</sub> (Hz)	10	10	10	10
F <sub>2</sub> (kHz)	0.2	0.4	0.6	22.5
F <sub>3</sub> (kHz)	8	16	24	900
F <sub>4</sub> (kHz)	40	120	120	1120

Nominal Bit Rate (kbit/s)	Demultiplexer Test (Generator Clock > Receiver Clock)			
	DS-1	DS-1C	DS-2	DS-3
A <sub>1</sub> (UI p-p)	—	4.0	8.0	14.0
A <sub>2</sub> (UI p-p)	—	0.05	0.05	0.05
F <sub>1</sub> (Hz)	—	10	10	10
F <sub>2</sub> (kHz)	—	0.25	0.2	3.2
F <sub>3</sub> (kHz)	—	20	32	900
F <sub>4</sub> (kHz)	—	120	160	1120

# Jitter Receiver

## DATA INPUTS

DS-1, DS-1C, DS-2 and DS-3 compatible ternary inputs.

**DS-1 Input** — Bell standard interface waveforms.

**Bit Rate:** 1544 kbit/s ± 50 ppm.

**Data Structure:** max of 14 zeros permitted regardless of input pattern.

**Format:** coded AMI (RZ).

**Impedance:** nominal 110Ω balanced to GND.

**Connector:** WECO Type 310A.

**Sensitivity:** accepts 3 selectable settings — DSX, DSX-MON, HI.

DSX-1: accepts Bell standard cross-connect waveform meeting CCITT Rec. G.703 Para. 1.

DSX-1-MON: same as DSX-1 but with 20 dB of attenuation.

DS-1-HI: same as DSX-1.

**Indicator:** LED illuminates if data transitions present.

**DS-1C Input** — Bell standard interface waveforms.

**Bit Rate:** 3152 kbit/s ± 50 ppm.

**Data Structure:** max of 14 zeros permitted regardless of input pattern.

**Format:** coded AMI (RZ).

**Impedance:** nominal 110Ω balanced.

**Connector:** WECO Type 310A.

**Sensitivity:** accepts 3 selectable settings — DSX, DSX-MON, HI.

DSX-1C: accepts Bell standard cross-connect waveform.

DSX-1C-MON: same as DSX-1C but with 20 dB of attenuation.

DS-1C-HI: same as DSX-1C.

**Indicator:** LED illuminates if data transitions present.

**DS-2 Input** — Bell standard interface waveforms.

**Bit Rate:** 6312 kbit/s ± 30 ppm.

**Format:** coded B6ZS (RZ).

**Impedance:** nominal 110Ω balanced.

**Connector:** WECO Type 310A.

**Sensitivity:** accepts 3 selectable settings — DSX, DSX-MON, HI.

DSX-2: accepts Bell standard cross-connect waveform meeting CCITT Rec. G.703 Para.2.

DSX-2-MON: same as DSX-2, but with 20 dB of attenuation.

DS-2-HI: nominally 50% duty cycle bipolar squarewave ± 2.1V ± 1 dB amplitude.

**Indicator:** LED illuminates if data transitions present.

**DS-3 Input** — Bell standard interface waveforms.

**Bit Rate:** 44736 kbit/s ± 20 ppm.

**Format:** coded B3ZS (RZ).

**Impedance:** nominal 75Ω unbalanced to GND.

**Connector:** WECO Type 560A.

**Sensitivity:** accepts 3 selectable settings — DSX, HI, DS-MON.

DSX-3: accepts Bell standard cross-connect waveform meeting CCITT Rec. G.703 Para.4. This corresponds to a DS-3-HI signal passed through the equivalent of 450 ft of WECO Type 728A cable.

DS-3-HI: Amplitude — 909 mV ± 1 dB pk.

Width (at ½ amplitude) — 11.2 ns ± 1.1 ns.

Transition Times — 4.5 ns ± 1.5 ns.

Overshoot/Undershoot — < 10% of pulse amplitude.

DS-3-MON: same as DS-3-HI, but with 13.8 dB of flat attenuation.

**Indicator:** LED illuminates if data transitions present.

## CLOCK

The jitter measurement is normally performed on the clock signal. If no CLOCK INPUT signal is present, the Receiver automatically selects the DATA INPUT. In the THROUGH DATA mode, the Receiver only measures from the CLOCK INPUT.

### Clock Input

**Frequency:** at internal rates (1544, 3152, 6312, 44736 kHz) ± 50 ppm.

**Impedance:** nominal 75Ω unbalanced.

**Connector:** BNC.

**Termination:** GND (ac coupled).

**Sensitivity:** compatible with nominal TTL or ECL signal levels.

**Note:** if using external RECEIVER REF CLOCK INPUT (rear panel), the CLOCK INPUT frequency range becomes 1544 to 44736 kHz. For optimum operation, select the nearest 'lower' internal rate so that the measurement bandwidth is that of the selected internal rate. The lower limit of measured jitter frequency becomes 0.1 Hz.

### Receiver Reference Clock Input/Output (rear panel)

**Function:** provides an OUTPUT for the derived reference clock when using the internal reference or, serves as an INPUT for an external reference clock.

**Input/Output Selection:** rear-panel switch.

**Frequency Range:** 1544 to 44736 kHz.

**Impedance:** nominal 50Ω unbalanced.

**Connector:** BNC.

**Termination:** nominal -2V.

**Sensitivity:** nominal ECL levels.

**Protection:** 100 mA fuse.

# JITTER MEASUREMENT

## Peak-peak Jitter

**Source:** DATA INPUT or CLOCK INPUT.

- Amplitude:** on RANGE 1 (at all internal bit rates) – 0.000 to 1.010 UI p-p as indicated on the display.  
 on RANGE 10 (at internal bit rates DS-1, DS-1C and DS-2) – 00.00 to 10.10 UI p-p as indicated on the display.  
 on RANGE 20 (at internal bit rate DS-3) – 00.00 to 20.20 UI p-p as indicated on the display.

The measurement ranges for the DATA INPUT, in terms of jitter amplitude vs jitter frequency, basically conform to the nominal limits specified in CCITT Rec. 0.171 Table 3 for the DS-1, DS-2 and DS-3 (up to 1.12 MHz). The nominal measurement ranges for the CLOCK INPUT are shown in brackets below.

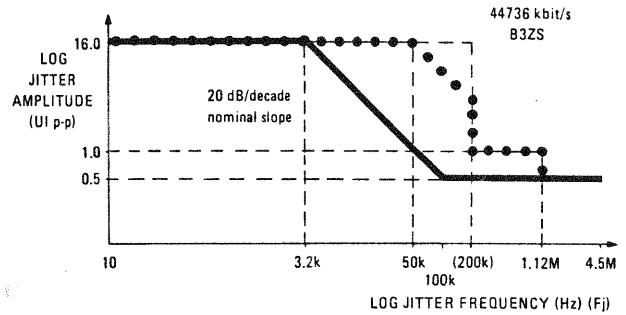
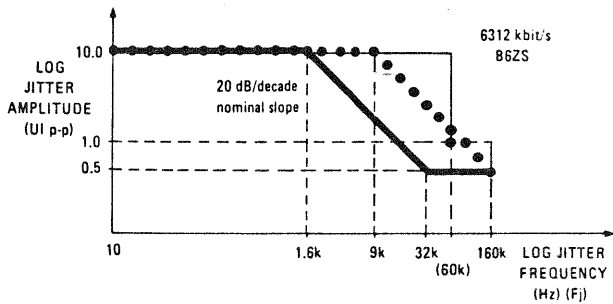
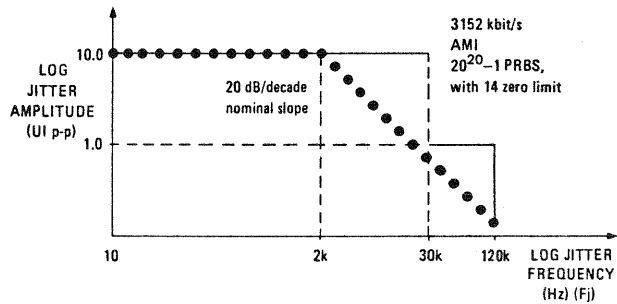
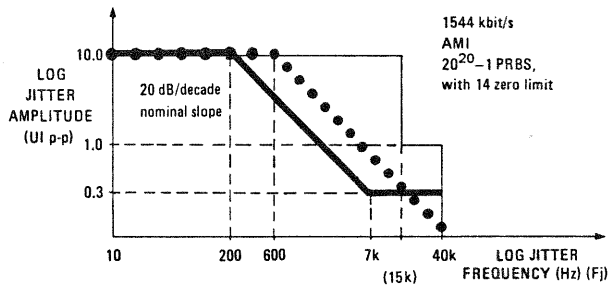

- CCITT data
- 3785B data
- 3785B clock

- Bandwidth:** on RANGE 1 – 20 Hz to that shown above.  
 on RANGE 10 – 5 Hz to that shown above.  
 on RANGE 20 – 5 Hz to that shown above.

**Note:** using the rear-panel RECEIVER REF CLOCK INPUT and the slowest display rate, the lower frequency limit of the measurement bandwidth can be reduced to 0.1 Hz.

- Display Rates:** FAST – valid for measurements on jitter frequencies > 10 Hz.  
 MED – valid for measurements on jitter frequencies > 1 Hz.  
 SLOW – valid for measurements on jitter frequencies > 0.1 Hz.

**Accuracy:** ± 4% + Additional Error as shown below.

Display Ranges	Nominal Clock Rate	Additional Error in UI p-p	
		Any Pattern (with appropriate coding)	Clock
RANGE 1	DS-1	≤ 0.050	≤ 0.010
	DS-1C	≤ 0.050	≤ 0.010
	DS-2	≤ 0.035	≤ 0.010
	DS-3	≤ 0.035	≤ 0.010
RANGE 10 (RANGE 20 for DS-3)	DS-1	≤ 0.12	≤ 0.10
	DS-1C	≤ 0.12	≤ 0.10
	DS-2	≤ 0.12	≤ 0.10
	DS-3	≤ 0.24	≤ 0.20

## Positive Peak/Negative Peak Jitter

- Range:** ½ specified range of the peak-peak measurement.  
**Bandwidth:** same as that specified for the peak-peak measurement.  
**Accuracy:** (with no filtering in the measurement path)  
 RANGE 1 – ± 5% ± 0.01 ± Additional Error (as in peak-peak).  
 RANGE 10 – ± 5% ± 0.10 ± Additional Error (as in peak-peak) for DS-1, DS-1C, DS-2.  
 RANGE 20 – ± 5% ± 0.2 ± Additional Error as in peak-peak) for DS-3.

### Internal Filtering

The internal filters, three for each rate, are those specified in CCITT Rec. 0.171 and the appropriate G.700 Series Recommendations requirements. The filters pre-shape the demodulated jitter before measurement of amplitude or jitter analysis and before providing a DEMODULATED JITTER OUTPUT at the rear panel.

**Nominal 3 dB Corner Frequencies:**

Nominal Bit Rate	DS-1	DS-1C	DS-2	DS-3
High Pass HP1	10 Hz	10 Hz	10 Hz	10 Hz
High Pass HP2	8 kHz	16 kHz	24 kHz	900 kHz
Low Pass LP	40 kHz	120 kHz	120 kHz	1.1 MHz

All filters have a nominal 20 dB/decade slope asymptote.

**Selection:** push-button giving any one of the following combinations — HP1 & LP; HP2 & LP; LP; No filters.

### JITTER ANALYSIS

The following measurements are made simultaneously, any result being accessed using the DISPLAY push-button, without interrupting the measurement in progress:

#### Hit Count

**Method:** totalises the number of occurrences when the received jitter amplitude exceeds a manually-settable threshold.

**Internal Gating:** any real-time interval, settable in the range — 1s to 59 min 59s in 1 s steps, and 1 hour to 23 hours 59 min in 1 min steps.  
SINGLE or REPETITIVE via START/STOP push-button.

**Manual Gating:** MAN mode via START/STOP push-button.

**Display:** 7-digit LED with leading zero blanking.

**Range:** when count exceeds 9999999, display automatically changes to A.BC X 10<sup>mn</sup> with automatic round-up to maximum count of 9.99 X 10<sup>13</sup>.

**Sensitivity:** typically ≥ 100 ns pulse width to count.

**Hit Threshold:** user defined in three ranges compatible with peak-peak jitter measurement.

RANGE 1 — 0.05 to 0.5 UI pk.

RANGE 10 — 0.5 to 5.0 UI pk (DS-1, DS-1C, DS-2 only).

RANGE 20 — 0.5 to 10.0 UI pk (DS-3 only).  
Typical Accuracy — ± 2%.

#### Hit Seconds

**Method:** totalises the number of seconds in which one or more hits occur.

**Gating:** same as HIT COUNT.

**Display:** same as HIT COUNT.

**Range:** same as HIT COUNT, except maximum count is 9.99 X 10<sup>7</sup>.

#### Hit Free Seconds

**Method:** totalises the number of seconds during which no hits occur.

**Gating:** same as HIT COUNT.

**Display:** same as HIT COUNT.

**Range:** same as HIT COUNT, except maximum count is 9.99 X 10<sup>7</sup>.

### Maximum in Interval

This measurement is made simultaneously with HIT COUNT, HIT SECONDS and HIT FREE SECONDS but the result is continuously displayed once START push-button has been pressed.

**Method:** holds the highest Receiver peak-peak jitter amplitude measured during the gating interval.

**Gating:** same as HIT COUNT.

**Display:** same as jitter measurement peak-peak.

**Range:** same as jitter measurement peak-peak.

**Bandwidth:** same as jitter measurement peak-peak.

**Accuracy:** same as jitter measurement peak-peak.

## ANNUNCIATORS & DISPLAYS

### Error Codes

Because certain states of the instrument can be recognised as invalid, error codes are displayed to inform the user of these conditions. An explanation of these codes is given below:

Error Code	Meaning	Display Used
1	The positive and negative peak displays indicate the position of the positive and negative peaks of the demodulated signal with respect to its mean. However due to the low frequency limits of the measurement bandwidth, the instrument may require several tens of seconds to establish the mean. It is therefore possible in a transient way for the mean to fall outwith the range of the demodulated signal, thus resulting in erroneous displays. Therefore Error Code 1 is displayed instead.	Received Jitter
5	HP-IB Address 31 not permitted.	Jitter Analysis
6	Talk only mode not permitted when an external controller connected.	Jitter Analysis
7	The instrument has been powered up from an off or power interrupt state, with the front panel switch settings successfully retained in non-volatile memory. The flashing Error Code 7 will cease when ANY switch is moved or any remote command is received via HP-IB.	Jitter Analysis
8	Similar to Error Code 7, but the front panel switch settings have not been successfully retained in non-volatile memory. Consequently, they have been set to default settings.	Jitter Analysis



## Status Indications

The following DISPLAYS and LEDs give the user a status indication of the instrument under certain conditions.

Display	Condition	Meaning
GENERATED JITTER Amplitude	Reading "0 ref"	Phase modulator switched off.
GENERATED JITTER Amplitude	Reading a value: > 20.20 (DS-3 only), > 14.00 (DS-3 only and in the THROUGH DATA mode), > 10.10 (DS-1, DS-1C, DS-2), and flashing.	Jitter amplitude required is beyond Generator capacity.
RECEIVED JITTER Amplitude	Reading a value: < 20.20 (RANGE 20; DS-3 only), < 10.10 (RANGE 10; DS-1, DS-1C, DS-2 only), < 1.010 (RANGE 1), and flashing.	Receiver phase-lock loop is out-of-lock.  Note: When the measurement is initially set-up, this condition will exist for approximately 15 seconds.
RECEIVED JITTER Amplitude	Reading a value: > 20.20 (RANGE 20; DS-3 only), > 10.10 (RANGE 10; DS-1, DS-1C, DS-2), > 1.010 (RANGE 1) or positive or negative peak reading; > 10.1 (RANGE 20; DS-3 only), > 5.05 (RANGE 10; DS-1, DS-1C, DS-2), > 0.505 (RANGE 1), and flashing.	Receiver jitter amplitude out of measurement range.
Jitter Analysis START/STOP LED	Flashing.	Receiver unable to do an analysis because: 1) no input signal, 2) Receiver phase-lock loop is out-of-lock.

## REAL-TIME CLOCK

When the DISPLAY push-button has selected TIME, local time can be viewed. By depressing the SET TIME push-button (LED illuminated), the local time can be set via the MANUAL control. By toggling the SET TIME push-button, LED extinguished, the real-time accumulates.

**Display:** HR MIN SEC.

**Accuracy:** setting tolerance better than  $\pm 3$  ppm at ambient temperature.

**Stability:** typically better than  $\pm 12$  ppm,  $0^{\circ}$  to  $55^{\circ}\text{C}$ ; typically better than  $\pm 5$  ppm/year ageing.

**Note:** when the real-time clock is set, the DAY count is initialised to 1. As 24-hours roll over, an output message 'DAY n' (where 'n' is the day count) is issued on the HP-IB, but not shown on the front-panel display. Total range of the clock is 99 days, 23 hours, 59 minutes and 59 seconds.

## OTHER INPUTS/OUTPUTS

### Demodulated Jitter Output (rear panel)

**Bandwidth:** as per jitter measurement peak-peak (lower limit 0.1 Hz for RECEIVER REF CLOCK INPUT).

**Impedance:** nominal voltage source.

**Connector:** BNC.

**Amplitude:** RANGE 1 – 1.0V/UI (p-p values).

RANGE 10 – 0.1V/UI (p-p values) for DS-1, DS-1C, DS-2.

RANGE 20 – 0.05V/UI (p-p values) for DS-3.

**Accuracy:** same as jitter measurement peak-peak.

**DC Content:** typically  $\leq 5\text{mV}$ .

### Measurement Input (rear panel)

**Selection:** enabled by rear-panel switch.

**Impedance:** nominal  $1\text{k}\Omega$ .

**Connector:** BNC.

By using the DEMODULATED JITTER OUTPUT and the MEASUREMENT INPUT, the user can insert his own specific measurement filtering.

## HP-IB FACILITIES

### General

**Modes:** "ADDRESSABLE" or "TALK ONLY", switch-selected (rear panel).

**LOCAL switch:** allows switching from 'remote' to 'local' control, except when the Controller has issued a "Local Lockout" command.

**Annunciators:** Remote, Listen, Talk, SRQ.

**Implementation:** SH1 (complete capability);  
 AH1 (complete capability);  
 T5 (basic talker, serial poll, talk only mode, unaddress if MLA);  
 TE $\emptyset$  (no capability);  
 L4 (basic listener, unaddress if MTA);  
 LE $\emptyset$  (no capability);  
 SR1 (complete capability);  
 RL1 (complete capability);  
 PP $\emptyset$  (no capability);  
 DC1 (complete capability);  
 DT $\emptyset$  (no capability);  
 C $\emptyset$  (no capability).

### Controlling Flags

To permit flexibility in the use of the 3785B, many of the important operating parameters are governed by 'flags'. At power-on these flags are given default values which may be overwritten in the local and remote states of the "ADDRESSABLE" mode. In the "TALK ONLY" mode, four of the flags are controlled by rear-panel switches. Full details are given in the 3785B Quick Reference Guide (5953-6670) or Operating Manual.

### ADDRESSABLE Mode

**Scope:** used when 3785B operates with an external Controller; allows control of all switches except Power, Line Voltage Selection, Local, HP-IB Address and ADDRESSABLE/TALK ONLY.

**Functions:** overwrite any switch or manual control setting; request any of five current displays; request annunciators; initialise real-time clock and interval timer; request the current switch positions and flags; load the switch positions and flags; "Local Lockout" facility; power-on reset; service requests controllable by flags.

### TALK ONLY Mode

**Scope:** used when the 3785B operates without an external Controller.

**Function:** provides output messages to a Peripheral such as 5150A (Option 001) Thermal Printer connected in "LISTEN ONLY" mode. Output result format is defined by a 4-segment TALK ONLY FORMAT CONTROL switch as follows:

1. Select between Receiver amplitude answers only and Receiver amplitude plus analysis answers. If the Receiver amplitude print-out is required, press the illuminated RANGE push-button to initiate a print-out of P-P, + PK and - PK.
2. Select time as a prefix to messages.
3. Select hit-second message output.
4. Select output of answers at end of gating period, always or only if hits have occurred.

## GENERAL

### Non-volatile Memory

A memory with battery back-up ensures that the front panel set-up is not destroyed at instrument power down. At power-up a check is made to confirm successful retention of memory. In the event of unsuccessful retention, the front panel is set to default settings and ERROR CODE 8 is flashed (see ERROR CODES).

### Power Supply

**Input Voltages:** 115V -22%, +10%; 230V -18%, +10%.

**Frequency:** ac 48 to 66 Hz.

**Consumption:** approx. 210VA.

**Probe Power:** +15V, 100mA; -12.6V, 100mA; ground; for active accessories.

### Physical

**Dimensions:** 195 mm (7.7 in) H, 335 mm (13.2 in) W, 475 mm (18.7 in) D.

**Weight:** 13 kg (28.7 lb), net; 15.5 kg (34.2 lb), shipping.

### Environment

For an instrument with battery supporting non-volatile memory for instrument settings:

**Operating Temperature:** 0 $^{\circ}$  to 50 $^{\circ}$ C.

**Storage Temperature:** -20 $^{\circ}$  to +70 $^{\circ}$ C (with battery charging inhibited at temperatures below 0 $^{\circ}$ C).

For an instrument without battery:

**Operating Temperature:** 0 $^{\circ}$  to 55 $^{\circ}$ C.

**Storage Temperature:** -40 $^{\circ}$  to +75 $^{\circ}$ C.

## Options

**Option 001** —as standard, but has Bantam Jacks (110 $\Omega$  balanced) replacing the WECO 310A Jacks and WECO 477B Jacks (75 $\Omega$  unbalanced large WECO) replacing the WECO 560A Jacks on the front-panel data outputs and inputs.

**Note:** this option provides the 3785B with connectors to enable direct application in the Canadian digital hierarchy.

**Option 061** —rack-mounted version.

**Option 062** —rack-mounted version with front-panel access to the rear-panel BNC connectors, Measurement and Reference switches.

**Option 910** —extra set of manuals.

## SECTION II

### INSTALLATION

#### 2-1 INTRODUCTION

2-2 This section contains information and instructions required to prepare the 3785B for use. Included in this section are the initial inspection procedures, power and grounding requirements, fuse selection procedure, installation information and instructions on repacking for shipment.

#### 2-3 INITIAL INSPECTION

##### WARNING

**To avoid hazardous electrical shock, do not perform electrical tests when there are signs of shipping damage to any portion of the outer enclosure (covers, panels, meters).**

2-4 Inspect the shipping container for damage. If the shipping container or cushioning material is damaged, it should be kept until the contents of the shipment have been checked for completeness and the instrument has been checked both mechanically and electrically. The contents of the shipment should be as shown in Figure 1-1 and listed in Paragraph 1-83. Procedures for checking electrical operation are given in Section IV of the Service Manual. If the contents of the shipment are incomplete, if there is mechanical damage or defect, notify the nearest Hewlett-

Packard Office. If the instrument does not pass the electrical performance checks given in Section IV of the Service Manual, notify the nearest Hewlett-Packard Office. If the shipping container is also damaged, or the cushioning material shows signs of stress, notify the carrier as well as the Hewlett-Packard Office. Keep the shipping materials for carrier's inspection. The Hewlett-Packard Office will arrange for repair or replacement without waiting for claim settlement.

#### 2-5 PREPARATION FOR USE

##### 2-6 Power Requirements



2-7 The 3785B requires a power source of 115V (+10%, -22%) or 230V (+10%, -18%) at a frequency between 48 to 66Hz. Total power consumption is approx 210VA.

##### CAUTION

**Before connecting this instrument to a power outlet ensure that the voltage selector is correctly set for the voltage of the power source and a fuse of the correct rating is fitted.**

##### 2-8 Line Voltage Selection



2-9 Figure 2-1 provides instructions on the setting of the voltage selector. Fuse ratings for the different power source voltages are given in Table 2-1.

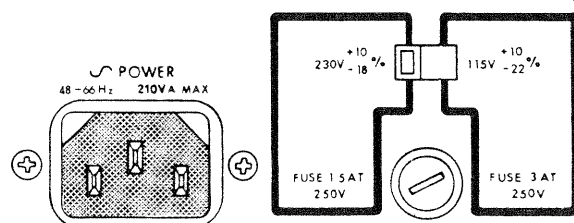

1. Remove power cord.
2. Insert screwdriver into slot of voltage selector and push to left or right (depending on supply voltage).
3. Unscrew fuse compartment end cap, fit appropriate fuse and replace end cap.

Figure 2-1 Line Voltage Selection

Table 2-1 Fuses

Nominal Line Voltage	Fuse Rating	HP Part Number
115V +10% -22%	*3A 250V (TIME DELAY)	2110-0381
230V +10% -18%	*1.5A 250V (TIME DELAY)	2110-0304

\*Appropriate fuse supplied with instrument.

2-10 Power Cord

2-11 The power cord supplied with each instrument varies with the country of destination. Figure 2-2 illustrates the standard power plug and cord configurations that are commonly used. The part number shown beneath each plug is the part number of the appropriate power cord and plug. If the appropriate power cord is not included with the instrument notify the nearest HP Sales/Service Office and a replacement will be provided.

8120-2104	8120-1369	*8120-1689	8120-1351	8120-1378	8120-2956

Note\*: Colour codes for each cable are: LINE-Brown, NEUTRAL-Blue, EARTH-Green/Yellow.

Figure 2-2 Power Cable and Mains Plug Part Numbers

WARNING

TO AVOID THE POSSIBILITY OF INJURY OR DEATH, THE FOLLOWING PRECAUTIONS MUST BE FOLLOWED BEFORE THE INSTRUMENT IS SWITCHED ON:

- (a) Note that the protection provided by grounding the instrument cabinet may be lost if any power cable other than the three-pronged type supplied is used to couple the ac line voltage to the instrument.
- (b) If this instrument is to be energized via an auto-transformer to reduce or increase the line voltage, make sure that the common terminal is connected to the neutral pole of the power source.
- (c) The power cable plug shall only be inserted into a socket outlet provided with a protective earth contact. The protective action must not be negated by the use of an extension cord without a protective conductor (grounding).

## 2-12 HP-IB Address Selection



2-13 The 3785B HP-IB talk and listen address switches and TALK ONLY FORMAT CONTROL switches are located on the rear panel.

2-14 Use a pencil to set the switches to the desired HP-IB address. The switches are illustrated in Figure 2-3. The allowable HP-IB address codes are given in Table 2-2.

## 2-15 Interconnections

2-16 Interconnection data for the Hewlett-Packard Interface Bus (HP-IB) is provided in Figure 2-4.

## 2-17 Mating Connectors

2-18 **Interface Connector.** The HP-IB mating connector is shown in Figure 2-4. (Note that the two securing screws are metric.)

2-19 **Coaxial Connectors.** Coaxial mating connectors used with this instrument should be 75Ω coaxial BNC male connectors, 50Ω coaxial BNC connectors, or, WECO Type 560A or 310A connectors.

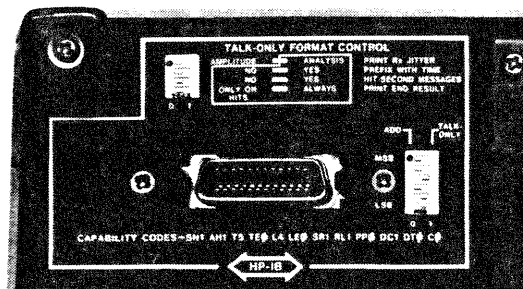

Figure 2-3 HP-IB Address and Talk Only Format Control Switches

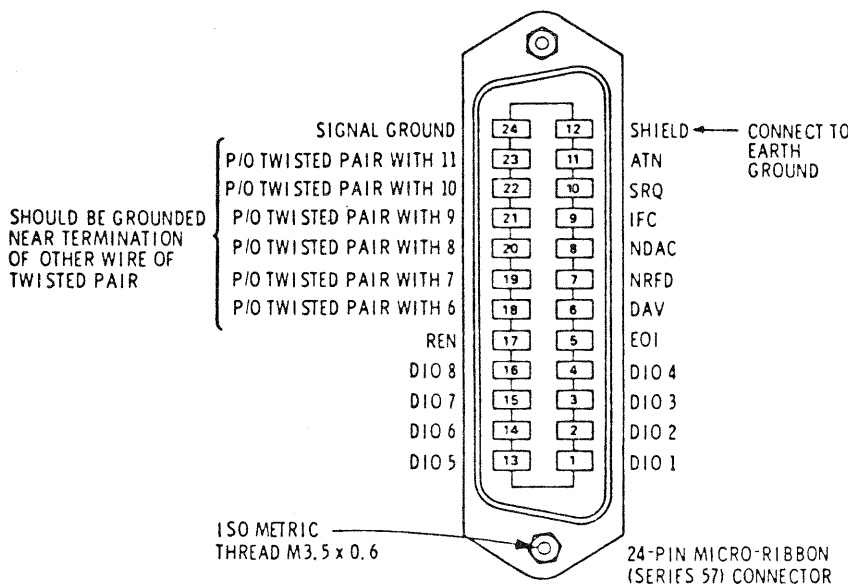

Figure 2-4 Hewlett-Packard Interface Bus Connection

### Logic Levels

The Hewlett-Packard Interface Bus logic levels are TTL compatible, i.e., the true (1) state is 0.0V dc to +0.4V dc and the false (0) state is +2.5V dc to +5.0V dc.

### Programming and Output Data Format

Refer to Section III (Operation).

### Mating Connector

HP1251-0293; Amphenol 57-30240.

### Mating Cables Available

- HP10631A, 1 metre (3.3ft)
- HP10631B, 2 metres (6.6ft)
- HP10631C, 4 metres (13.2ft)
- HP10631D, 0.5 metres (1.6ft)

### Cabling Restrictions

1. An HP-IB System may contain no more than 2 metres (6ft) of connecting cable per instrument.
2. The maximum accumulative length of connecting cable for any HP-IB System is 20.0 metres (65.6ft).

Table 2-2 Allowable HP-IB Address Codes 

Address Switches					Talk Address Character	Listen Address Character	Decimal Equivalent
A5	A4	A3	A2	A1			
0	0	0	0	0	@	SP	0
0	0	0	0	1	A	!	1
0	0	0	1	0	B	"	2
0	0	0	1	1	C	#	3
0	0	1	0	0	D	\$	4
0	0	1	0	1	E	%	5
0	0	1	1	0	F	&	6
0	0	1	1	1	G	'	7
0	1	0	0	0	H	(	8
0	1	0	0	1	I	)	9
0	1	0	1	0	J	*	10
0	1	0	1	1	K	+	11
0	1	1	0	0	L	,	12
0	1	1	0	1	M	-	13
0	1	1	1	0	N	.	14
0	1	1	1	1	O	/	15
1	0	0	0	0	P	0	16
1	0	0	0	1	Q	1	17
1	0	0	1	0	R	2	18
1	0	0	1	1	S	3	19
1	0	1	0	0	T	4	20
1	0	1	0	1	U	5	21
1	0	1	1	0	V	6	22
1	0	1	1	1	W	7	23
1	1	0	0	0	X	8	24
1	1	0	0	1	Y	9	25
1	1	0	1	0	Z	:	26
1	1	0	1	1	[	;	27
1	1	1	0	0	\	<	28
1	1	1	0	1	]	=	29
1	1	1	1	0	^	>	30

**2-20 Operating Environment**

2-21 The instrument should be operated in temperatures within the range 0°C to +50°C and at altitudes up to 4,500 metres (15,000ft). At all times the instrument should be protected from temperature extremes and environments which cause condensation within the instrument.

**2-22 RACK MOUNTING**

2-23 A Rack Mount Kit is available for use with the 3785B and can be purchased from your nearest Hewlett-Packard Office. To obtain a retro-fittable Rack Mount Kit, order HP Part Number 03771-60105. (Note: This Rack Mount Kit does not give front-panel access to the rear-panel connectors.)

2-24 Instructions on conversion to rack mounting are included with the rack mount kit and are also reproduced on Page 2-6 for convenience.

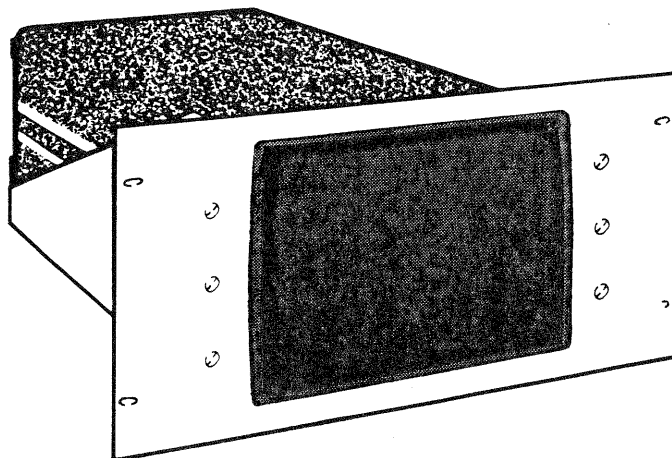
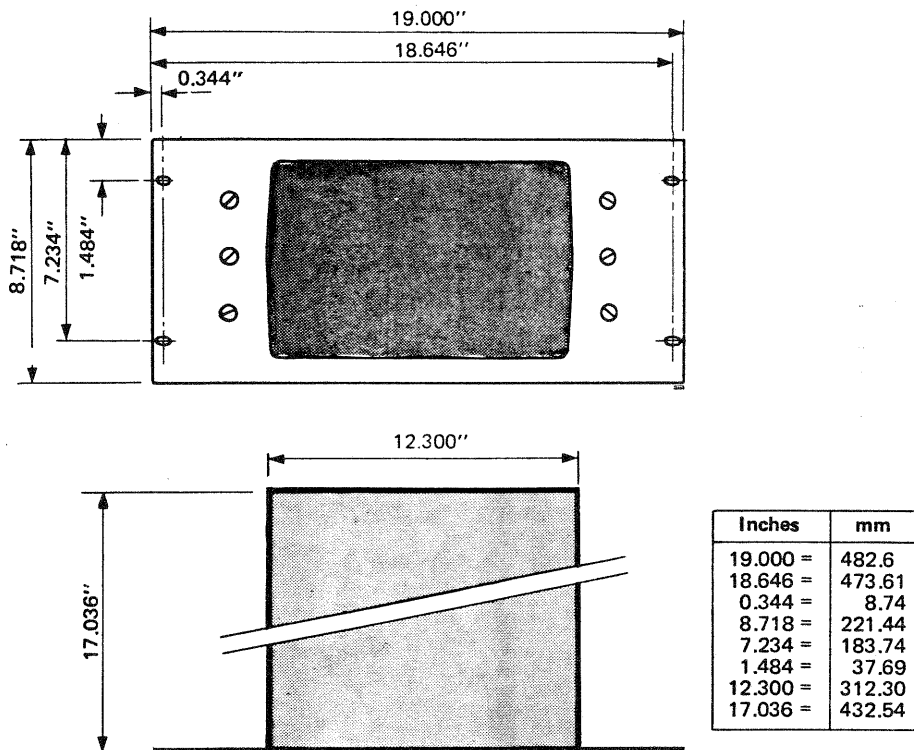

Figure 2-5 Rack Mounting

**RETRO-FIT INSTRUCTIONS FOR RACK MOUNTING**

If it is required to rack mount this instrument, order Rack Mount Kit HP Part Number 03771-60105. Parts relevant to rack-mounting this instrument, which are contained in this kit, are listed in Table 1.

**Table 1 Rack Mount Kit Contents**

Description	HP Part Number	Quantity
Rack Front Panel	03771-20056	1
Rack Tray	03770-11160	1
Screw	2940-0115	6
Nut	2950-0004	6
Washer-Lock	2190-0060	6
Screw	2360-0133	2
Washer-Flat	3050-0010	2
Washer-Lock	2190-0006	2
Washer-Flat	3050-8735	6

*Discard all other parts contained in kit*

**Retro-fitting Procedure**

1. Ensure that the instrument is switched-off and the power cord is disconnected.
2. Referring to Figure 1, remove the push-fit hub cover (MP5) from both sides of the instrument. (Finger pressure only is required to unclip MP5.) Discard the hub covers.
3. Remove the three locating screws on each side of the handle.
4. Remove and discard the handle (MP4), springs (MP3) and gear rings (MP1).
5. Re-locate the gear hubs (MP2) -- without screws -- to their original locations. (These parts act as spacers between the instrument frame and the rack tray shown in Figure 2.)
6. Locate the instrument into rack tray. Ensure that instrument rubber feet locate into eccentric slots in rack tray and gear hubs (MP2) line-up with holes at side of rack tray.
7. Retain rack tray to instrument by fixing screws (Part No. 2360-0133) through side of rack tray into centre of gear hub (MP2). **Do not tighten screws.**
8. Mount rack front panel (MP10) onto rack tray, using six sets of screws, lock washers and nuts. (Note: the rack front panel is asymmetrical and will only fit in one position.)
9. Tighten all screws.

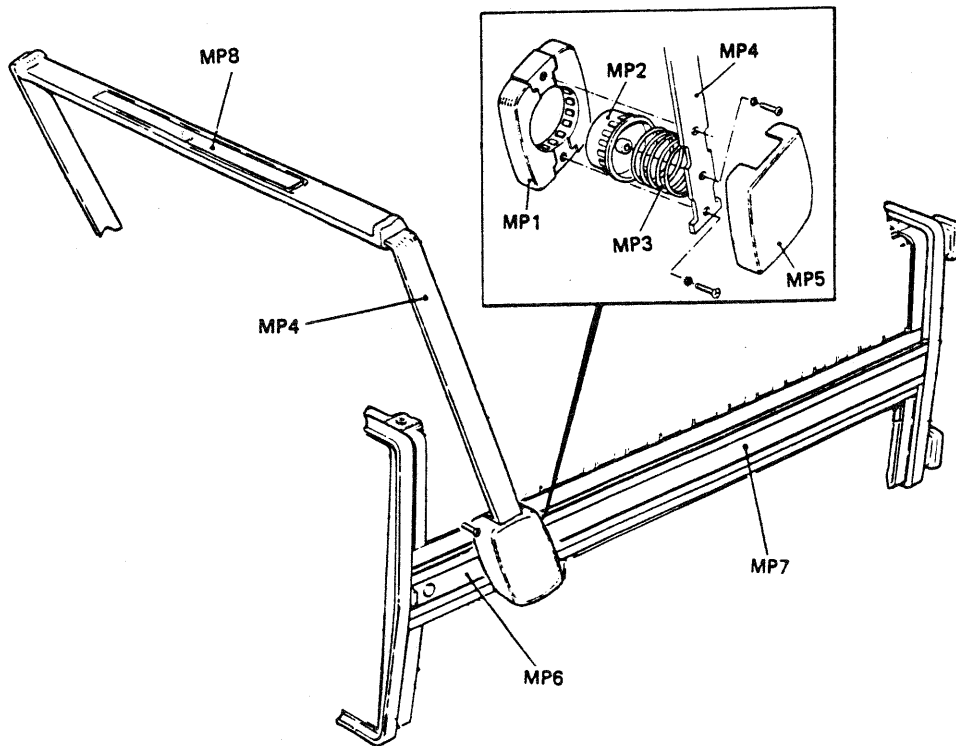

**Figure 1 Hardware Details**



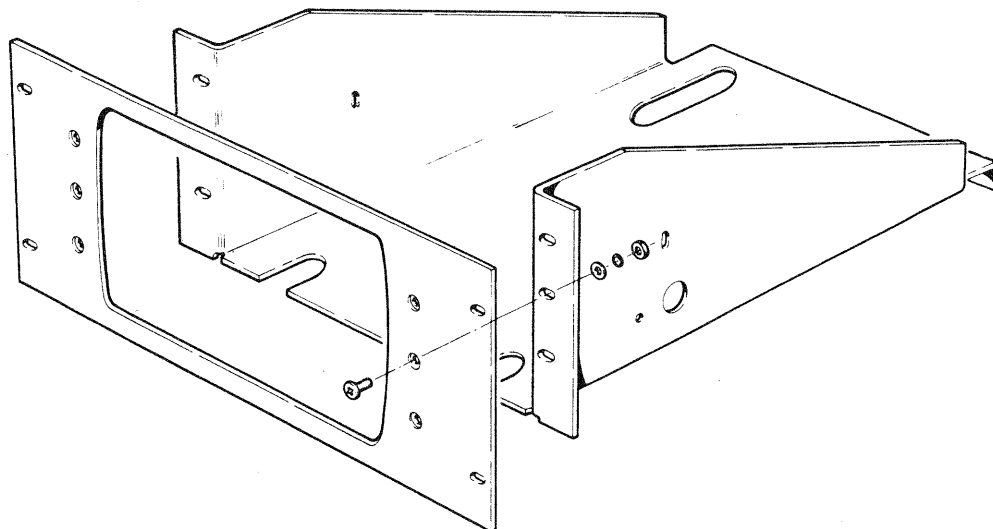

Figure 2 Rack Mount Hardware

## 2-25 STORAGE AND SHIPMENT

### 2-26 Environment

2-27 The instrument may be stored or shipped in environments within the following limits:

Temperature	.....	-20°C to + 70°C
Altitude	.....	Up to 15,200 metres (50,000 feet)

The instrument should also be protected from temperature extremes which cause condensation within the instrument.

### 2-28 Repackaging for Shipment

2-29 **Tagging for Service.** If the instrument is being returned to Hewlett-Packard for service, please complete one of the blue repair tags located at the beginning of the Service Manual and attach it to the instrument.

2-30 **Original Packaging.** Containers and materials identical to those used in factory packaging are available through Hewlett-Packard Offices. If the instrument is being returned to Hewlett-Packard for servicing, attach a tag indicating the

type of service required, return address, Model number, and full serial number. Also, mark the container FRAGILE to ensure careful handling. In any correspondence, refer to the instrument by Model number and full serial number.

2-31 **Other Packaging.** The following general instructions should be used for re-packing with commercially available materials.

- (a) Wrap instrument in heavy paper or plastic. (If shipping to Hewlett-Packard Office or Service Centre, attach a tag indicating type of service required, return address, model number and full serial number.)
- (b) Use strong shipping container. A double wall carton made of 350-pound test material is adequate.
- (c) Use a layer of shock-absorbing material 70 to 100 mm (3- to 4-inch) thick around all sides of the instrument to provide firm cushioning and prevent movement inside container. Protect control panel with cardboard.
- (d) Seal shipping container securely.
- (e) Mark shipping container FRAGILE to ensure careful handling.
- (f) In any correspondence, refer to instrument by Model number and full serial number.

## 2-32 BATTERY OPERATION

2-33 The 3785B has a built-in re-chargeable battery pack. This battery ensures that the front-panel set-up is not destroyed at instrument power-down. The battery pack is automatically re-charged when the 3785B is powered from the mains supply.

### WARNING

**Do not short the battery terminals. This may result in overheating which can cause burns or increased risk of fire.**

**Do not incinerate or mutilate the battery. It may burst or release toxic materials — causing personal injury.**

**This is a Nickel-Cadmium battery and should be disposed of in accordance with Government Regulations.**

## 2-34 Battery Removal

### WARNING

**This procedure requires access to the interior of the instrument. Switch off the instrument and disconnect the mains cord before proceeding.**

2-35 Remove the top cover and remove the printed-circuit board assembly guide. Remove Assembly A39 from the motherboard connector and carefully raise until the battery is accessible. Remove the battery from the spring clips.

## 2-36 Battery Installation

2-37 With Assembly A39 raised from the motherboard and the battery removed, as in Paragraph 2-34, the instrument is ready for battery replacement. A replacement battery (Part Number 1420-0282) is available from your nearest Hewlett-Packard Office.

2-38 Insert the battery in the spring clips on Assembly A39 with the +ve terminal in the +ve marked clip. (The +ve terminal should be nearest to the instrument front-panel when Assembly A39 is in position.) Re-situate Assembly A39, checking all cables. Replace the assembly guide and the instrument top cover.

### CAUTION

**Do not mix different batteries in the instrument.**

**Do not use batteries other than those specified.**

**Observe polarity orientation between battery and holder.**

## SECTION III

### OPERATION

#### 3-1 INTRODUCTION

3-2 This section explains the functions of the controls, connectors and indicators of the HP Model 3785B Jitter Generator and Receiver. Also included are instructions for switch-on procedure, a description of Error Codes and Operators Maintenance. A detailed operating procedure is given in the Operating Manual (Part Number 03785-90001).

3-3 For convenience, the fold-out contains the key to all front-panel controls, etc.

#### 3-4 POWER CONTROLS AND CONNECTORS

3-5 Details of setting the supply voltage and fuse selection are given in Section II.

#### WARNING

**Before the instrument is switched on, all protective earth terminals, extension cords, auto-transformers and devices connected to it**

**should be connected to a protective earth ground socket. Any interruption of the protective earth grounding will cause a potential shock hazard that could result in personal injury.**

**Only fuses with the required rated current and of specified type should be used. Do not use repaired fuses or short-circuited fuse holders. To do so could cause a shock or fire hazard.**

#### CAUTION

**Before the instrument is switched-on, it must be set to the voltage of the power source or damage to the instrument may result.**

3-6 The POWER switch (2) controls the ac power input to the instrument.



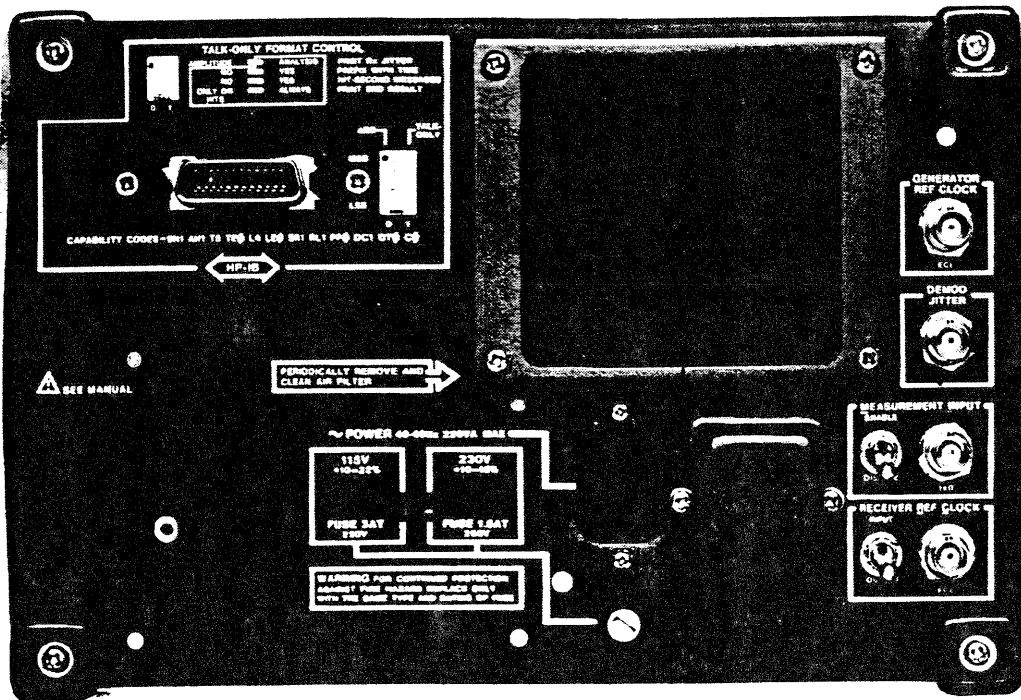
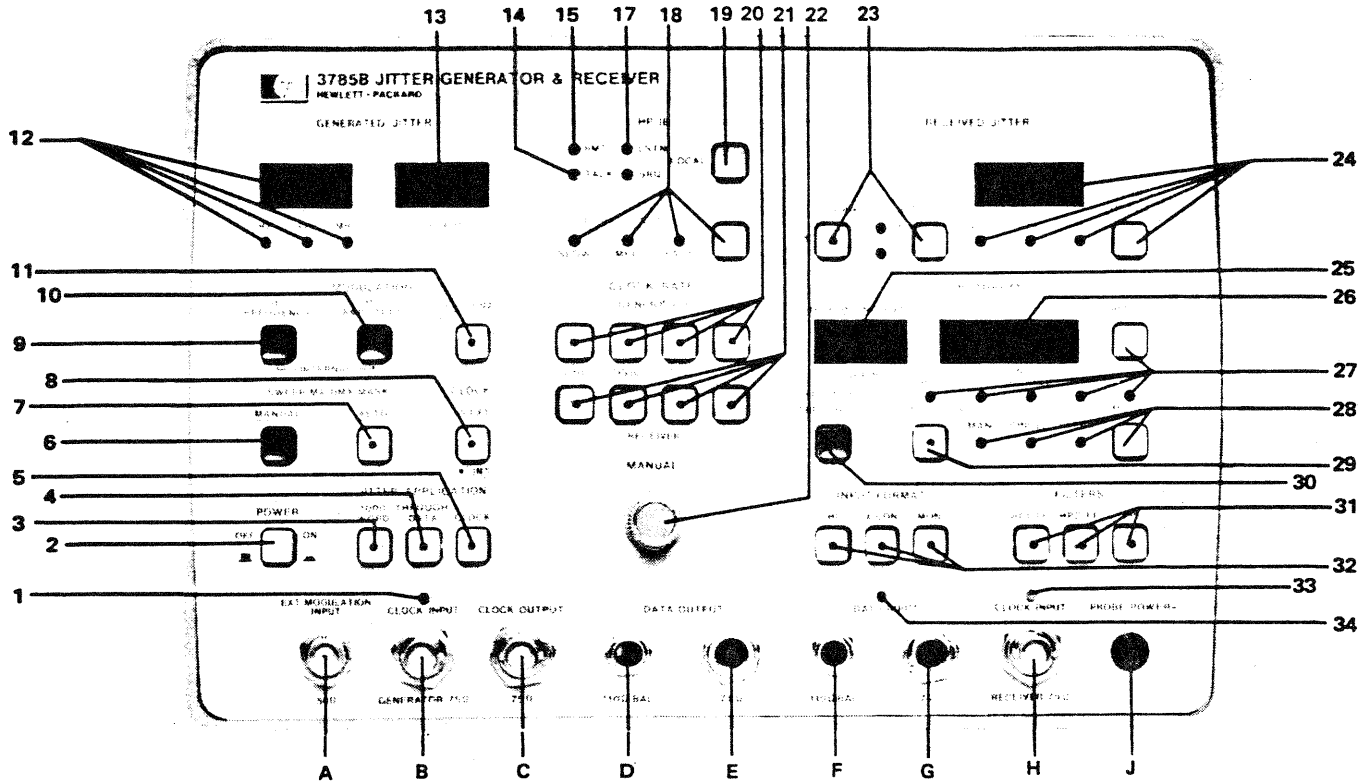
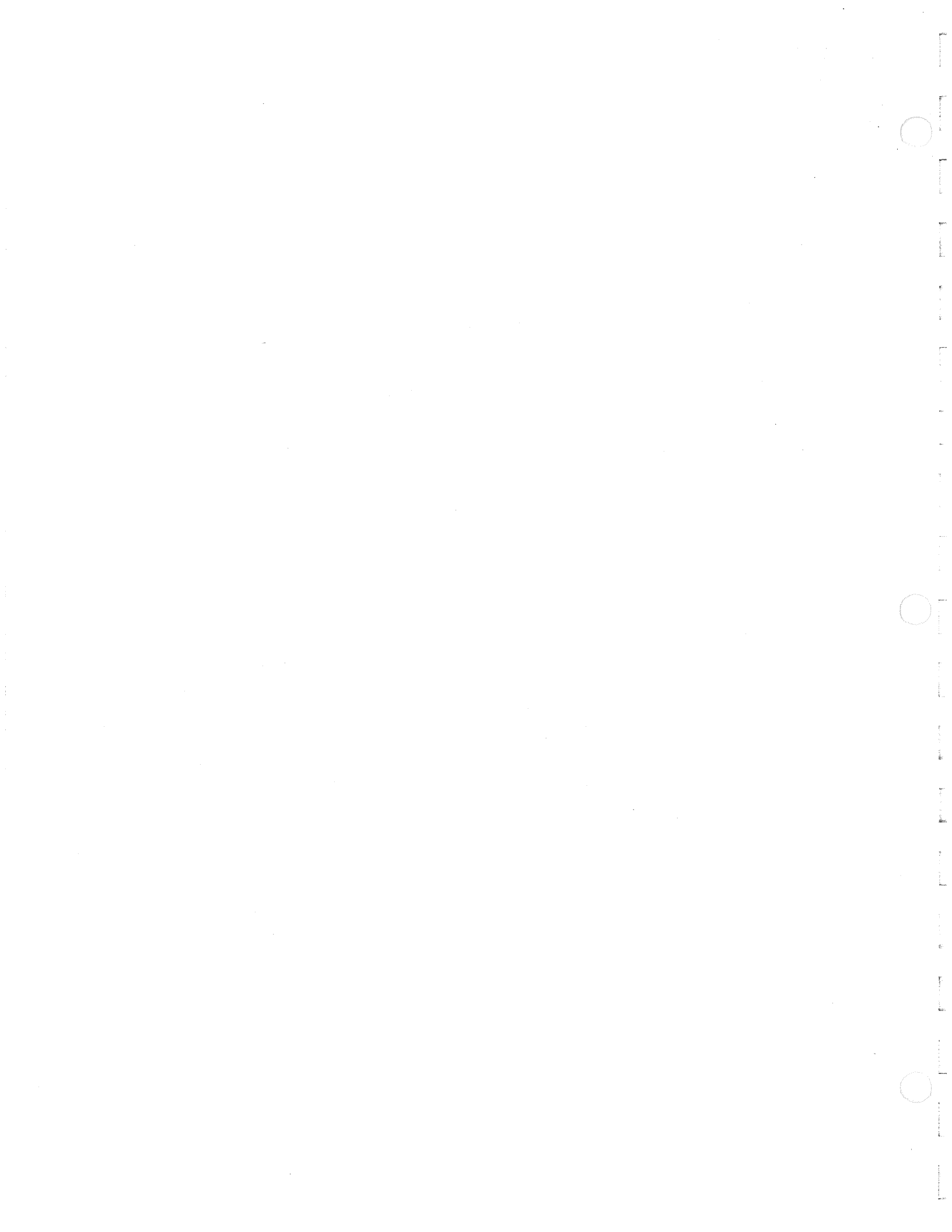

Figure 3-1 Key to Controls, Connectors and Indicators



### 3-7 CONTROLS, CONNECTORS AND INDICATORS

#### 3-8 Front-Panel Description

- A** EXT MODULATION INPUT meets the BELL requirements of CCITT Rec. 0.171 for sinusoidal modulation (dc to 5% of bit rate is typical – 2.5% of bit rate DS-3). The maximum input voltage acceptable is 1.2V p-p. The maximum jitter amplitude (applied to either the clock signal or data signal) is 10.10 UI p-p for DS-1, DS-1C and DS-2, or, 20.20 UI p-p for DS-3.
- B** CLOCK INPUT–GENERATOR accepts an external clock input signal within  $\pm 10\%$  of the internal clock frequencies (1544, 3152, 6312 and 44736kHz). The maximum acceptable input amplitude is 5V p-p within excursion limits of  $\pm 5V$ . This  $75\Omega$  unbalanced input has a sensitivity better than 500mV p-p. The CLOCK INPUT LED (1) illuminates if clock transitions are present.
- C** CLOCK OUTPUT automatically selects TTL levels for DS-1, DS-1C or DS-2 and ECL levels for DS-3. This  $75\Omega$  unbalanced output provides a square wave with a  $50 \pm 6\%$  duty cycle. (Note: The CLOCK OUTPUT and DATA OUTPUT signals are not available simultaneously.)
- D**  $110\Omega$  BAL DATA OUTPUT – DS-1, DS-1C or DS-2 (X CON) – provides the necessary signals and levels corresponding to CCITT (BELL) Rec. G703 – depending on the GENERATOR CLOCK RATE push-buttons (20). (Note: The DATA OUTPUT and CLOCK OUTPUT signals are not available simultaneously.)
- E**  $75\Omega$  DATA OUTPUT – DS-3 (X CON) – provides the necessary signals and levels corresponding to CCITT (BELL) Rec. G703 – depending on the GENERATOR CLOCK RATE push-buttons (20). (Note: The DATA OUTPUT and CLOCK OUTPUT signals are not available simultaneously.)
- F**  $110\Omega$  BAL DATA INPUT accepts signals and levels from the appropriate hierarchy levels, corresponding to CCITT (BELL) Rec. G703 – depending on the RECEIVER CLOCK RATE push-buttons (21) and the INPUT FORMAT push-buttons (32). An LED (34) is illuminated if data transitions are present.
- G**  $75\Omega$  DATA INPUT accepts signals and levels from the appropriate hierarchy level corresponding to CCITT (BELL) Rec. G703 – depending on the RECEIVER CLOCK RATE DS-3 push-button (21) and the INPUT FORMAT push-buttons (32). An LED (34) is illuminated if data transitions are present.
- H** CLOCK INPUT–RECEIVER accepts an external clock input signal within  $\pm 50\text{ppm}$  of the internal clock frequencies. An LED (33) above the input is illuminated if data transitions are present. This  $75\Omega$  unbalanced input is ac-coupled and has a sensitivity compatible with TTL or ECL levels.
- J** PROBE POWER supplies power to an Active Probe. The voltages available are +15V, –12.6V and GND with a maximum current of 100mA.
- 1** CLOCK INPUT LED illuminates if clock transitions are present at the GENERATOR CLOCK INPUT (B).
- 2** POWER switch activates the entire instrument by controlling the ac supply.
- 3** 1000 WORD (JITTER APPLICATION) push-button controls the internally-generated repetitive word sequence “1000” When the push-button LED is illuminated, the repetitive word sequence is generated. If required, a jitter signal can be applied to the “1000” word.
- 4** THROUGH DATA (JITTER APPLICATION) push-button controls the through data information. When the push-button LED is illuminated, data correctly applied to the Receiver input is internally routed to the jitter Generator. If required, jitter can be applied to the data signal to provide a jittered DATA OUTPUT signal. Note: There will be a 3 second delay for centralization of the buffer store.
- 5** CLOCK (JITTER APPLICATION) push-button controls the clock information. The clock signal may be either internal or external – depending on the CLOCK push-button (8). When the push-button LED is illuminated, the clock output is activated. If required, jitter can be applied to the clock signal.
- 6** MANUAL (SWEEP MX/DMX MASK) push-button, when LED is illuminated, enables the pre-programmed jitter frequency/amplitude mask to be swept using the MANUAL control (22).
- 7** AUTO (SWEEP MX/DMX MASK) push-button, when LED is illuminated, enables the pre-programmed jitter frequency/amplitude mask to be swept automatically by the internal software. (Note: If the selected RECEIVER CLOCK RATE is less than the selected GENERATOR CLOCK RATE, the mask will be a DEMUX mask. Otherwise, a MUX mask will be provided – see Specifications.)





- 8 CLOCK push-button selects the internally-generated or externally-applied clocks. When the push-button LED is illuminated, the clock signal used is the one applied to the CLOCK INPUT (B). When the push-button LED is extinguished, the clock signal used is internally derived. (Note: If the selected RECEIVER CLOCK RATE is less than the selected GENERATOR CLOCK RATE, the mask will be a DEMUX mask. Otherwise, a MUX mask will be provided – see Specifications.)
- 9 SET FREQUENCY (MODULATION) push-button, when illuminated, enables the jitter frequency to be set by the MANUAL control (22).
- 10 SET AMPLITUDE (MODULATION) push-button, when illuminated, enables the jitter amplitude to be set by the MANUAL control (22).
- 11 EXTERNAL push-button, when illuminated, enables the instrument to accept an external jitter modulating source via the EXT MODULATION INPUT (A). The jitter modulating frequency can be read from the external source and the jitter amplitude read on the GENERATED JITTER amplitude display (13).
- 12 GENERATED JITTER frequency LEDs and display show the internal jitter modulating frequency – set by the SET FREQUENCY push-button (9) and the MANUAL control (22).
- 13 GENERATED JITTER amplitude display shows the jitter amplitude generated either internally by the SET AMPLITUDE push-button (10) and the MANUAL control (22), or externally by an external jitter modulating source connected to the EXT MODULATION INPUT (A).
- 14 TALK LED (HP-IB function) indicates that the 3785B is able to pass information over the HP-IB.
- 15 REMOTE LED (HP-IB function) indicates that the 3785B is being controlled from an external source.
- 16 SRQ LED (HP-IB function) indicates that the 3785B is requesting service from the HP-IB Controller.
- 17 LISTEN LED (HP-IB function) indicates that the 3785B is listening to information from the HP-IB.
- 18 DISPLAY RATE push-button and LEDs govern the rate at which the Receiver jitter display is updated, and the Generator display when the EXT MODULATION INPUT (A) is used. When the jitter modulation is internally generated, the rate at which the Generator jitter amplitude display is updated is automatically selected to suit the jitter modulating frequency. The three rates (SLOW, MED and FAST) are selected sequentially by the push-button. The SLOW, MED and FAST rates have refresh cycles enabling measurement at jitter frequencies of  $\geq 0.1\text{Hz}$ ,  $\geq 1\text{Hz}$  and  $\geq 10\text{Hz}$  respectively.
- 19 LOCAL push-button (HP-IB function) allows the 3785B to be switched from Remote to Local control (indicated by the REMOTE LED (15)) except when a 'Local Lockout' signal has been issued by the Controller. When the REMOTE LED is extinguished, the 3785B is being controlled from the front panel.
- 20 GENERATOR CLOCK RATE push-buttons select the internal clock sources of 1.544, 3.152, 6.312 and 44.736Mb/s representing DS-1, DS-1C, DS-2 and DS-3 respectively. The appropriate push-button LED is illuminated for the frequency selected.
- Note: Selection of the Generator and Receiver clock rates are completely separate, allowing cross-multiplex testing. In the THROUGH DATA mode, the GENERATOR CLOCK RATE determines the bit rate of operation and the RECEIVER CLOCK RATE determines the clock frequency at which jitter measurements are performed on a clock signal applied to the CLOCK INPUT (H).*
- 21 RECEIVER CLOCK RATE push-buttons select the internal clock sources of 1.544, 3.152, 6.312 and 44.736Mb/s representing DS-1, DS-1C, DS-2 respectively. The appropriate push-button LED is illuminated for the frequency selected.
- Note: Selection of the Generator and Receiver clock rates are completely separate, allowing cross-multiplex testing. In the THROUGH DATA mode, the GENERATOR CLOCK RATE determines the bit rate of operation and the RECEIVER CLOCK RATE determines the clock frequency at which jitter measurements are performed on a clock signal applied to the CLOCK INPUT (H).*
- 22 MANUAL control is used in conjunction with the MANUAL push-button (6), SET FREQUENCY push-button (9), SET AMPLITUDE push-button (10) and SET PEAK THRESHOLD & SET TIME/INT push-button (30). When used with the MANUAL push-button (6), the MANUAL control allows the operator to sweep through the internal jitter tolerance mask. When used with the SET FREQUENCY (9) or SET AMPLITUDE (10) push-buttons, the MANUAL control allows the operator to set the desired frequency or amplitude respectively. When used with the SET PEAK THRESHOLD or SET TIME/INT push-button (30), the MANUAL control enables

the operator to set-up the peak jitter amplitude threshold for jitter analysis operation or, adjust the real-time clock or time interval gating period.

- 23 RANGE (UI p-p) push-buttons give a choice of 1, 10 or 20 UI p-p. The appropriate push-button LED is illuminated for the range selected. RANGE 1 applies to all internal bit rates; RANGE 10 applies to internal bit rates DS-1, DS-1C and DS-2; and RANGE 20 applies to bit rate DS-3. Better accuracy and resolution are obtained on RANGE 1 but it has a limited frequency range compared with RANGE 10 and RANGE 20. To obtain a hard-copy of the measured jitter (P-P, +PK and -PK) on a peripheral (such as a Thermal Printer), press the illuminated RANGE push-button.
- 24 PEAK SELECT push-button, LEDs and display allow the operator to select which of the simultaneous jitter measurements - peak-to-peak (P-P), positive peak (+PK) or negative peak (-PK) will be shown on the display.

**Note: All controls and displays numbered (25) to (30) apply exclusively to the JITTER ANALYSIS section of operation.**

- 25 MAX IN INTERVAL display will show the maximum p-p jitter amplitude measured during the current gating period. (The RECEIVED JITTER display (24) shows the instantaneous jitter.)
- 26 JITTER ANALYSIS display will show all information selected by the DISPLAY push-button (27).
- 27 DISPLAY push-button and LEDs enable selection and interrogation of five functions. When the HITS LED is illuminated, the JITTER ANALYSIS display (26) will show the current jitter hits count. When the HIT SECONDS LED is illuminated, the JITTER ANALYSIS display will show the current jitter hit seconds count. When the HIT FREE SECONDS LED is illuminated, the JITTER ANALYSIS display will show the current jitter hit-free seconds count. When the TIME LED is illuminated, the JITTER ANALYSIS display will show the current reading of the internal real-time clock. When the INTERVAL LED is illuminated, the JITTER ANALYSIS display (26) will show the elapsed gating period.

However, when the above LEDs are illuminated and the SET PEAK THRESHOLD & SET TIME/INT push-button LED (30) is illuminated, the various parameter settings can be viewed and altered using the MANUAL control (22).

When either the HITS, HIT SECONDS or HIT FREE SECONDS LEDs are illuminated and the SET PEAK THRESHOLD push-button (30) is selected - the JITTER ANALYSIS display (26) will show the current peak threshold above which the jitter hits will be counted and will enable this setting to be altered using the MANUAL control (22). When the TIME LED is illuminated and the SET TIME/INT push-button (30) is selected, the JITTER ANALYSIS display (26) will show the 'frozen' time display and enables the real-time clock to be reset using the MANUAL control (22). When the INTERVAL LED is illuminated and the SET TIME/INT push-button (30) is selected, the JITTER ANALYSIS display (26) will show the current interval setting and enable this setting to be altered using the MANUAL control (22).

- 28 MODE push-button and LEDs enable selection of the gating period. The three gating periods - MANual, SINGLE and REPEAT (repetitive) over the time INTERVAL (27). These gating periods are used under control of the STOP/START push-button (29). When the START push-button is pressed for a REPEAT gating period, both the SINGLE and REPEAT LEDs will illuminate to indicate the first period of a repetitive gating mode. With the HITS LED illuminated, the JITTER ANALYSIS display (26) will also show a running total during this first gating period. For subsequent gating periods, it will show the total at the end of the previous gating period.

During the gating period, the following are available -

1. The five DISPLAY (27) functions can be interrogated without disturbing the measurement in progress.
  2. The MAX IN INTERVAL display (25) is kept updated and is available to the operator.
  3. The instantaneous Received Jitter (P-P, +PK, -PK) can be interrogated by PEAK SELECT (24) without disturbing the measurement in progress.
  4. The SET PEAK THRESHOLD & SET TIME/INT push-button (30) can be used to change these parameters without stopping the measurement in progress.
- 29 START/STOP push-button initiates/halts the gating periods selected by the MODE push-button (28). When the LED flashes, the Receiver is unable to perform a jitter analysis because - either there is no input signal or the Receiver phase-lock loop is out-of-lock. On each occasion that START is pressed the user defined threshold value is output to the Printer.

- 30 Set PEAK THRESHOLD & SET TIME/INT push-button is used with the DISPLAY push-button and LEDs (27) as described under front-panel control 27.
- 31 FILTERS push-buttons enable selection of an appropriate filter for the demodulated jitter before the measurement of amplitude. Three filters (HP1/LP, HP2/LP and LP) are also superimposed on the rear-panel DEMODULATED JITTER OUTPUT. When a filter is selected, the appropriate push-button LED is illuminated. If all push-button LEDs are extinguished, no filter has been selected.
- 32 INPUT FORMAT push-buttons select the input format required to match the interface connection. For each rate there are three selectable settings — HI, X CON and MON. In the X CON mode, the instrument accepts the Bell standard cross-connect waveform meeting CCITT Rec. G.703 Para. 1 (for DSX-1), Para. 2 (for DSX-2) or Para. 4 (for DSX-3). In the MON mode, the instrument accepts the DSX-1, DSX-1C and DSX-2 signals but with 20dB of attenuation; and the DS-3 HI signal with 13.8dB of flat attenuation. Note: the DATA OUTPUT format is always in the X CON form, conforming with CCITT Rec. G703 Para. 1 (for DSX-1), Para. 2 (for DSX-2) or Para. 4 (for DSX-3).
- 33 CLOCK INPUT LED illuminates if clock transitions are present at the RECEIVER CLOCK INPUT (H). If no clock input is present, the Receiver automatically selects the DATA INPUT. In the THROUGH DATA mode, the Receiver only measures from the CLOCK INPUT.
- 34 DATA INPUT LED illuminates if data transitions are present at the DATA INPUTs (F) or (G).

### 3-9 Rear-Panel Description

GENERATOR REFERENCE CLOCK supplies an unjittered clock output signal based on either an externally-generated clock applied to the front-panel CLOCK INPUT, or, one of the internally-generated clocks.

DEMODULATED JITTER OUTPUT amplitude is 1.0V/UI p-p on RANGE 1; 0.1V/UI p-p on RANGE 10 (for DS-1, DS-1C and DS-2); 0.05V/UI p-p on RANGE 20 (for DS-3). This output can be used to:

1. View the jitter spectrum on a Spectrum Analyzer.
2. Measure the rms value of the received jitter.
3. In conjunction with the MEASUREMENT INPUT, allow external filtering to be applied before the jitter measuring circuitry.

MEASUREMENT INPUT is selected by a rear-panel switch and has a nominal impedance of  $1k\Omega$ .

RECEIVER EXTERNAL REFERENCE CLOCK INPUT/OUTPUT can be used either as an input for an external reference clock or as an output for the internally-derived reference clock. This feature is switch selectable. The frequency range of the port is 1.544MHz to 44.736MHz with a nominal impedance of  $50\Omega$ .

HP-IB. The 3785B accepts and supplies information via this rear-panel socket. The HP-IB facility can control all switches except POWER and LOCAL. The REMOTE, TALK, LISTEN and SRQ LEDs indicate the HP-IB status of the 3785B.

TALK ONLY FORMAT CONTROL switch is a 4-segment switch which defines the output result format. The output result is defined as follows:

1. Select between Receiver Amplitude answers only, or, Receiver Analysis answers and Receiver Amplitude answers.
2. Select time as a prefix to messages.
3. Select hit-second message output.
4. Select output of answers at end of gating period.

**3-10 SWITCH-ON PROCEDURE**

3-11 The 3785B requires an ac power supply of 115V (+15%, -22%) or 230V (+10%, -18%) at 48 to 66Hz and consumes approx 210V.

**WARNING**

Before the instrument is switched on, all protective earth terminals, extension cords, auto-transformers and devices connected to it should be connected to a protective earth grounded socket. Any interruption of the protective earth grounding will cause a potential shock hazard that could result in personal injury.

Only fuses with the rated current and specified type should be used. Do not use repaired fuses or short-circuited fuseholders. To do so could cause a shock or fire hazard.

**CAUTION**

Before the instrument is switched on, it must be set to the voltage of the power source or damage to the instrument may result.

Fuses: 220/240V - 1.5AT (slow-blow)  
 hp 2110-0304  
 100/120V - 3AT (slow-blow)  
 hp 2110-0381

3-12 The instrument is ready for operation immediately after switch-on.

**3-13 ERROR CODES**

3-14 Because certain states of the instrument can be recognised as invalid, error codes are displayed to inform the user of these conditions. An explanation of these codes is given in Table 3-1. The status indications (Table 3-2) indicate the status of the instrument under certain conditions.

**Table 3-1 Error Code Description**

Error Code	Meaning	Display Used
1	The positive and negative peak displays indicate the position of the positive and negative peaks of the demodulated signal with respect to its mean. However, due to the low-frequency limit of the measurement bandwidth, the instrument may require several tens of seconds to establish the mean. It is therefore possible, in a transient way, for the mean to fall out-with the range of the demodulated signal thus resulting in erroneous displays. Therefore, ERROR CODE 1 is displayed instead.	"RECEIVED JITTER"
5	HP-IB Address '31' not permitted.	"JITTER ANALYSIS"
6	TALK ONLY mode not permitted when an external Controller connected.	"JITTER ANALYSIS"
7	The instrument has been powered-up from an off or power-interrupt state, with the front-panel switch settings successfully retained in non-volatile memory. The flashing ERROR CODE 7 will cease when any switch is moved or any 'remote' command is received via the HP-IB.	"JITTER ANALYSIS"
8	Similar to ERROR CODE 7, but the front-panel switch settings have <b>not</b> been successfully retained in non-volatile memory. Consequently, they have been set to default values.	"JITTER ANALYSIS"

There are five possible causes for ERROR CODE 8 being displayed.

1. The VOL/NON VOL link on Assembly A39 is set to VOL.
2. The battery is discharged.
3. A switch has been pressed (either 'locally' or 'remotely') or the MANUAL control adjusted just as the power went down.
4. Power went down during the 3 second THROUGH DATA sequence.
5. Following the use of signature analysis (Processor troubleshooting).

**Table 3-2 Status Indications**

Display	Condition	Meaning
GEN JITTER Amplitude	Reading "0 ref"	Phase modulator switched off.
GEN JITTER Amplitude	Reading a value: >20.20 (DS-3 only) >14.00 (DS-3 only and in the THROUGH DATA mode), >10.10 (DS-1, DS-1C, DS-2) and flashing.	Jitter amplitude required is beyond Generator capacity.
REC JITTER Amplitude	Reading a value: <20.20 (RANGE 20, DS-3 only), <10.10 (RANGE 10, DS-1, DS-1C, DS-2 only), <1.010 (RANGE 1) and flashing.	Receiver phase-lock loop is out-of-lock.  <i>Note: When measurement initially set-up, this condition will exist for approx 15 seconds.</i>
REC JITTER Amplitude	Reading a value: >20.20 (RANGE 20, DS-3 only), <10.10 (RANGE 10; DS-1, DS-1C, DS-2 only), >1.011 (RANGE 1) or positive or negative peak reading, >10.1 (RANGE 20, DS-3 only), >5.05 (RANGE 10; DS-1, DS-1C, DS-2 only), >0.505 (RANGE 1) and flashing.	Received jitter amplitude out of measurement range.
START/STOP push-button LED (Jitter Analysis)	Flashing	Receiver unable to perform analysis because: 1. no input signal, 2. Receiver phase-lock loop is out-of-lock.

**3-15 OPERATORS MAINTENANCE**

3-16 Operators Maintenance consists of replacing defective fuses and cleaning the air filter. These items are discussed in the following paragraphs.

**WARNING**

**It is important that the following maintenance procedures be executed according to the recommended schedule to retain the safety features which have been designed into the instrument.**



**3-17 Fuses**

3-18 The ac line fuse, located at the rear of the instrument may be replaced by the operator. The ac line cord should be disconnected from the power source and the other end disconnected from the instrument. With the power cord removed, the fuse compartment may be opened. The fuse is removed by unscrewing the fuse compartment end cap. For detailed information on fuse replacement and values, refer to Section II.



**3-19 Air Filter**

3-20 The fan has a filter attached from the outside, for ease of cleaning and replacement. This filter should be removed and cleaned at intervals of approximately one month, depending on the environment. To service the filter, remove the four screws holding the filter to the rear panel.

**WARNING**

**The instrument should not be operated with the air filter removed and the fan blades exposed.**

3-21 Wash the filter mesh in clean soapy water, rinse thoroughly and dry before refitting, or, replace the filter with Part Number 03782-60057.

### 3-22 OPERATORS CHECKS

### 3-23 BACK-TO-BACK CHECKS

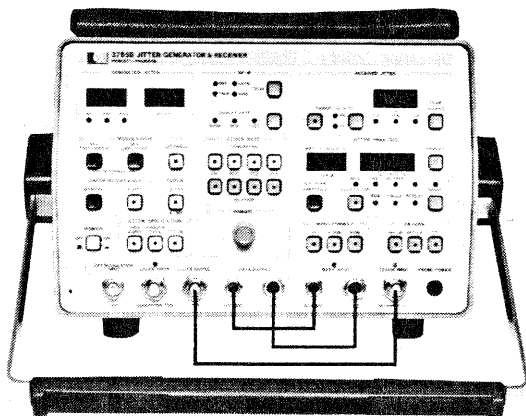

3-24 The Back-to-Back Checks allow the operator to check the basic functions of the instrument prior to use. (A complete specification check is given in Section IV of the Service Manual.)

1. Ensure the mains selector setting and fuse rating are correct for the power line in use (see Section II). Connect the 3785B to the mains supply.
2. Switch on 3785B. All front-panel LEDs should illuminate and the display windows should read all '8s'. After a brief period, all LEDs should extinguish except for certain switch settings.

*Note: These switch settings are dependent upon the display shown in the JITTER ANALYSIS window. If a flashing "7" is displayed in the JITTER ANALYSIS window, this indicates that power interrupt has occurred and that the front-panel switch settings and control flags have been successfully retained in the non-volatile memory. If a flashing "8" is displayed in the JITTER ANALYSIS window, this indicates that power interrupt has occurred and that the front-panel switch settings and control flags have not been successfully retained in the non-volatile memory. Consequently, the front-panel switch settings and control flags have been set to their default values. (If a flashing "8" is present, consult Section IV of the Service Manual or Table 3-1 in the Operating Manual.)*

3. To remove the flashing "7" or "8" from the JITTER ANALYSIS window, press any push-button.
4. It may be necessary to set the following switches/control flags:

JITTER APPLICATION.....	CLOCK
DISPLAY RATE.....	FAST
GENERATOR CLOCK RATE.....	DS-3
RECEIVER CLOCK RATE.....	DS-3
RANGE.....	20 UI P-P
PEAK SELECT.....	P-P
DISPLAY.....	TIME
MODE.....	MAN
INPUT FORMAT.....	X CON
FILTERS.....	OFF
MEAS. INPUT (rear panel).....	DISABLE
REC. REF CLOCK (rear panel).....	OUTPUT
ADDRESS (rear-panel).....	TALK ONLY

*Ensure all other LEDs (except TALK and an INPUT LED - if cables connected) are extinguished.*

### JITTERED CLOCK GENERATION

5. Press the SET FREQUENCY push-button (check LED illuminates). Check that the MANUAL control can be used to alter the GENERATED JITTER Frequency display. Set the GENERATED JITTER Frequency display reading to 100Hz.
6. Press the SET AMPLITUDE push-button (check LED illuminates). Check that the MANUAL control can be used to alter the GENERATED JITTER Amplitude display. Set the GENERATED JITTER Amplitude display reading to 8.00 UI p-p.

*The GENERATOR is now set to provide a CLOCK OUTPUT signal - jittered at a frequency of 100Hz and level of 8 UI p-p - as indicated by the GENERATED JITTER Frequency and Amplitude displays.*

### JITTERED CLOCK MEASUREMENT

7. Connect the GENERATOR CLOCK OUTPUT to the RECEIVER CLOCK INPUT and check that the CLOCK INPUT LED illuminates. After a few seconds, the RECEIVED JITTER display will settle to provide a reading of the p-p received jitter. By pressing the PEAK SELECT push-button; the p-p, +pk or -pk levels will be displayed - shown by the appropriate illuminated LED.

8. Check the SET AMPLITUDE LED is illuminated. Using the MANUAL control, set the GENERATED JITTER Amplitude display reading to 0.8 UI p-p. Press the RANGE 1 push-button (check LED illuminates). After a few seconds the RECEIVED JITTER display will settle to provide a reading of the received jitter. This reading may be either p-p, +pk or -pk depending upon the mode of the PEAK SELECT push-button. Press the PEAK SELECT push-button until the P-P LED illuminates.

#### JITTERED DATA GENERATION

9. Press the 1000 WORD push-button (check LED illuminates).

*The GENERATOR is now set to provide a 1000 WORD DATA OUTPUT signal – jittered at a frequency of 100Hz and level of 0.8 UI p-p – as indicated by the GENERATED JITTER Frequency and Amplitude displays.*

#### JITTER DATA MEASUREMENT

10. Connect the 75 $\Omega$  DATA OUTPUT to the 75 $\Omega$  DATA INPUT. Check that the DATA INPUT LED illuminates. After a few seconds the RECEIVED JITTER display will settle to give a measurement of the received jitter.
11. Press the RANGE 10/20 push-button (check LED illuminates). Press CLOCK push-button (check LED illuminates). Steps 5 to 10 can be repeated for any matching GENERATOR/RECEIVER CLOCK RATE settings.

*Note: The 110 $\Omega$  DATA OUTPUT can be connected to the 110 $\Omega$  DATA INPUT, using the appropriate balanced cable, for clock rates DS-1, DS-1C and DS-2 in Step 10.*

#### JITTER ANALYSIS

12. Reset the controls as per Step 4.
13. Press the SET TIME/INT push-button (check LED illuminates) and, using the MANUAL control, set the JITTER ANALYSIS display window reading to the real time. Press the SET TIME/INT push-button (check LED extinguishes) and check the clock display starts to increment.
14. Press the DISPLAY push-button and check that the INTERVAL LED illuminates. Press

the SET TIME/INT push-button (check LED illuminates). Using the MANUAL control, set the JITTER ANALYSIS display to read 1 min.

15. Press the DISPLAY push-button until either the HITS, HIT SECONDS or HIT FREE SECONDS LED illuminates. Press the SET PEAK THRESHOLD push-button (check LED illuminates). The peak threshold level in UI, displayed in the JITTER ANALYSIS window, can now be set using the MANUAL control in the range 0.5 to 10.0 UI. Set the JITTER ANALYSIS display to read 0.5 UI. Press the SET PEAK THRESHOLD push-button (check LED extinguishes).
16. To allow a functional check of the JITTER ANALYSIS mode, the jitter tolerance mask sweep facility of the Generator can be used. This sweep may be performed either manually or automatically.
17. Press the MANUAL (SWEEP MASK) push-button (check LED illuminates). The MANUAL control can be used to sweep the jitter frequency through the internal jitter tolerance mask.
18. Press the AUTO push-button (check LED illuminates). Observe the GENERATED JITTER Frequency and Amplitude displays. The Frequency display will increment from a minimum value to a maximum value with a corresponding change in level – corresponding to the built-in mask specifications. Once the instrument has completed a sweep, a reverse sweep will start automatically. (Note: As the jitter tolerance mask is being swept automatically, the RECEIVED JITTER display will read the instantaneous p-p jitter amplitude. This amplitude will vary because of the implementation of the jitter tolerance mask.)
19. Press the DISPLAY push-button until the INTERVAL LED illuminates. Press the START push-button (check LED illuminates). The JITTER ANALYSIS display should show time incrementing in 1 second intervals. This is the elapsed measurement time. After a suitable period (approx 45 seconds) press the STOP push-button (check LED extinguishes).
20. Press the DISPLAY push-button until the HITS LED illuminates. The JITTER ANALYSIS window will show the total number of jitter hits recorded over the selected measurement period. The MAX IN INTERVAL display will show the maximum p-p jitter received during the measurement interval.

21. Press the DISPLAY push-button until the HIT SECONDS LED illuminates. The JITTER ANALYSIS window will show the number of seconds during the selected measurement period when hits occurred. Similarly, when the HIT FREE SECONDS LED is illuminated, the number of seconds free of hits during the selected measurement period will be displayed.
22. Press the MODE push-button until the SINGLE LED illuminates.
23. Press the START push-button (check LED illuminates). At the end of the measurement period (determined by the INTERVAL setting), the START push-button LED will automatically extinguish and the measurement will stop. Repeat Steps 20 and 21.
24. Press the MODE push-button until the REPEAT LED illuminates.
25. Press the START push-button (check LED illuminates). When the START push-button is pressed for a REPEAT gating period, both the SINGLE and REPEAT LEDs will illuminate to indicate the first period of a repetitive gating mode. The JITTER ANALYSIS display will also show a running hits total during this first gating period (when the HITS LED is illuminated).
26. At the end of the first measurement period, the totalized results are held in the JITTER ANALYSIS window. The instrument automatically starts another measurement period. At the end of sub-

sequent measurement periods, the totalized results are updated.

27. To terminate this repetitive jitter analysis measurement, press the STOP push-button.
28. To stop the jitter mask being swept automatically, press either the SET FREQUENCY, SET AMPLITUDE or MANUAL (SWEEP MX/DMX MASK) push-button.

#### MEASUREMENT FILTERS

29. Reset the controls as per Step 4.
30. Press the GENERATOR CLOCK RATE DS-2 and RECEIVER CLOCK RATE DS-2 push-buttons (check LEDs illuminate).
31. Press the SET FREQUENCY push-button (check LED illuminates) and, using the MANUAL control, set the GENERATED JITTER Frequency display to read 24kHz.
32. Press the SET AMPLITUDE push-button (check LED illuminates) and, using the MANUAL control, set the GENERATED JITTER Amplitude display to read 2 UI.
33. Check that the RECEIVED JITTER display reads approximately 2 UI.
34. Press the HP2/LP FILTER push-button (check LED illuminates) and check that the RECEIVED JITTER display reads approximately 1.4 UI.



### 3-25 USING A THERMAL PRINTER

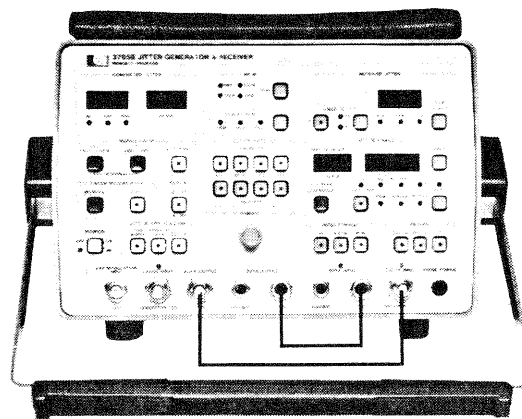
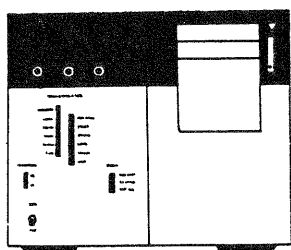

An HP-IB compatible Thermal Printer (eg HP Model 5150A Option 001) can be connected to the 3785B to provide a hard-copy print-out of measurement results.

1. Set the Thermal Printer to the "LISTENING" mode.
2. Set the 3785B rear-panel ADDRESS switch to TALK ONLY and the TALK ONLY FORMAT CONTROL switches to "1110" (ANALYSIS, YES, YES, ONLY ON HITS).

3. Connect the 3785B and Thermal Printer using an HP-IB cable and power-up the Thermal Printer. Connect the signal cables.
4. Press the illuminated RANGE push-button and check that the Printer gives a reading. A typical example is given below:

```
16-34-35 -P 1.02
16-34-35 +P 0.99
16-34-35 PP 2.01
```

#### TALK ONLY FORMAT CONTROL Switch

Segment	Description
1	Select between Receiver amplitude answers only, or Receiver amplitude answers and Receiver analysis answers.
2	Select time as a prefix to messages.
3	Select hit-second message output.
4	Select output of answers at end of gating period, always or only if hits have occurred.

**Note:** If a Receiver amplitude print-out is required press the illuminated RANGE push-button to initiate a print-out of P-P, +PK and -PK.

5. Perform the 3785B BACK-TO-BACK CHECKS (if desired) and ensure that the Receiver is in-lock and giving a suitable reading.

**Note:** If not wishing to perform the entire BACK-TO-BACK CHECKS, just perform Paragraph 3-24 Steps 1 through 4.

6. Connect the signal input cable (if not already connected). The Printer will give an IN-LOCK print-out.

- Disconnect the signal input cable and the Printer will give an OUT-OF-LOCK print-out, as shown:

Time in  
HH MM SS  
format

---

```
16-35-16 R CLK OFF
16-35-15 R OUT LOCK
```

- Reconnect the signal input cable and the Printer will give an IN-LOCK print-out, as shown:

```
16-35-40 R IN LOCK
16-35-27 R CLK ON
```

To verify the JITTER ANALYSIS section, the internal jitter tolerance mask in the Generator is used to simulate a changing JITTER AMPLITUDE and JITTER FREQUENCY signal for analysis.

- Press the DISPLAY push-button until the INTERVAL LED illuminates. Press the SET TIME/INT push-button (check LED illuminates) and, using the MANUAL control, set the JITTER ANALYSIS display reading to 1 minute. Press the SET TIME/INT push-button (check LED extinguishes).
- Press the MODE push-button until the SINGLE LED illuminates.
- Press the AUTO push-button (LED illuminates) quickly followed by pressing the MANUAL push-button (LED illuminates). This initializes the jitter tolerance mask to the start position.
- Ensure the Receiver is in-lock.
- Press the DISPLAY push-button until either the HITS, HIT SECONDS or HIT FREE SECONDS LED illuminates. Press the SET PEAK THRESHOLD push-button (check LED illuminates) and, using the MANUAL control, set the JITTER ANALYSIS display to read 0.50UI.
- Press the SET PEAK THRESHOLD push-button (check LED extinguishes).
- Press the START push-button (check LED illuminates). Press the AUTO push-button

(check LED illuminates). The Printer will print-out a display similar to that shown below:

16-38-20	HF	35	— Total hit-free seconds count.
16-38-20	HS	25	— Total hit seconds count.
16-38-20	HT	6500	— Total hits count.
16-38-20	MI	2.02	— Max amplitude recorded.
16-37-45	HS#	6500	
16-37-44	HS#	6112	
16-37-43	HS#	5217	
16-37-42	HS#	4220	
16-37-41	HS#	3379	
16-37-40	HS#	2908	
16-37-39	HS#	2345	
16-37-38	HS#	1917	
16-37-37	HS#	1599	
16-37-36	HS#	1329	
16-37-35	HS#	1098	
16-37-34	HS#	881	
16-37-33	HS#	713	
16-37-32	HS#	575	
16-37-31	HS#	461	
16-37-30	HS#	364	
16-37-29	HS#	288	
16-37-28	HS#	231	
16-37-27	HS#	186	
16-37-26	HS#	151	
16-37-25	HS#	112	
16-37-24	HS#	77	
16-37-23	HS#	52	
16-37-22	HS#	27	
16-37-21	HS#	12	
16-37-20	TH	0.50	
16-37-20	START		

The print-out will stop automatically when the measurement is completed and the START/STOP LED will extinguish.

- Press the MODE push-button until the REPEAT LED illuminates. Press the AUTO push-button (LED illuminates) quickly followed by pressing the MANUAL push-button (LED illuminates). This initializes the jitter tolerance mask to the start position.
- Check the Receiver is in-lock.
- Press the START push-button (check LED illuminates). Press the AUTO push-button (check LED illuminates).

19. The DISPLAY push-button can be used to access any of the displays in the JITTER ANALYSIS section. Press the DISPLAY push-button until the HITS LED illuminates. The JITTER ANALYSIS display will show the running total of the jitter hits during the gating period.
20. Press the SET PEAK THRESHOLD push-button (check LED illuminates). The JITTER ANALYSIS display will show the threshold value. This value can be adjusted, using the MANUAL control.
21. Press the SET PEAK THRESHOLD push-button (check LED extinguishes). The Printer will print-out showing that a new threshold has been initialized during the gating period (see the print-out below for a typical display).
22. Press the DISPLAY push-button until the HIT SECOND LED illuminates. The JITTER ANALYSIS display will show the running total during the gating period.
23. Press the DISPLAY push-button until the HIT FREE SECOND LED illuminates. The JITTER ANALYSIS display will show the running total during the gating period.
24. Press the DISPLAY push-button until the TIME LED illuminates. The JITTER ANALYSIS display will show the real-time.
25. Press the DISPLAY push-button until the INTERVAL LED illuminates. The JITTER ANALYSIS display will show the elapsed measurement period.

```

16-44-04 HF      46
16-44-04 HS      14
16-44-04 HT     840
16-44-04 MI     2.21
16-43-23 TH     2.21  New
                       -threshold
                       level
16-43-18 HS#    840
16-43-18 TH SET UP
16-43-17 HS#    737
16-43-16 HS#    595
16-43-15 HS#    479
16-43-14 HS#    379
16-43-13 HS#    295
16-43-12 HS#    231
16-43-11 HS#    186
16-43-10 HS#    153
16-43-09 HS#    118
16-43-08 HS#     81
16-43-07 HS#     56
16-43-06 HS#     29
16-43-05 HS#     11
16-43-04 TH     0.50
16-43-04 START
    
```

26. Press the SET TIME/INT push-button (check LED illuminates). The JITTER ANALYSIS display will show the gating interval for the measurement.
27. Press the SET TIME/INT push-button (check LED extinguishes).

The measurement in progress is uninterrupted while these parameters are being monitored.

The MAX IN INTERVAL display is continuously updated during the gating period.

The RECEIVED JITTER display shows the instantaneous received jitter analysis at that instant in time. If a hard-copy of the instantaneous value is required, press the illuminated RANGE push-button to activate the Printer.

3-26 MULDEM MEASUREMENTS

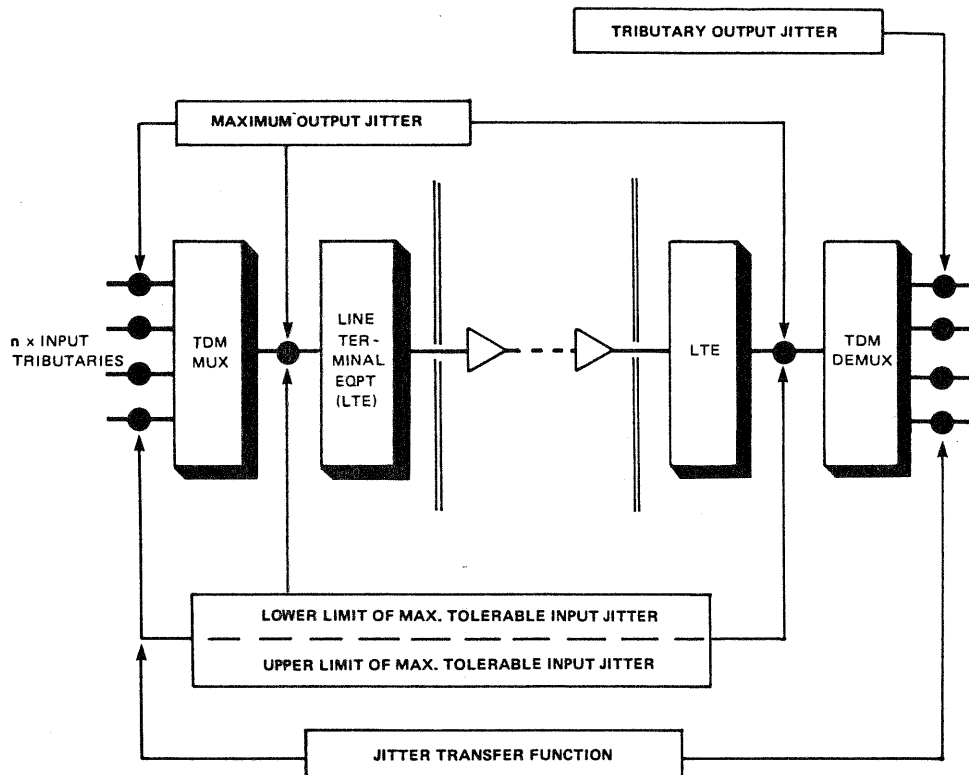

**INTRINSIC OUTPUT JITTER and TRIBUTARY OUTPUT JITTER**

The 3785B Receiver section is used to measure the output jitter (in the absence of intentionally applied jitter) at the interface points of the digital system.

**Procedure**

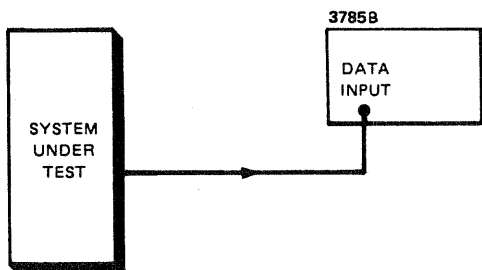

1. Connect the point of interest (CCITT G703 BELL Interface) of the System Under Test to the 3785B DATA INPUT (either 110Ω BAL or 75Ω UNBAL).

2. Select the appropriate clock rate by pressing the desired RECEIVER CLOCK RATE push-button (check LED illuminates). Set the measurement filter (if desired) using the appropriate FILTER push-button.
3. The intrinsic jitter of the System Under Test will be displayed in the RECEIVED JITTER window. The resolution may be changed using the RANGE push-buttons. The PEAK SELECT push-button will select between a peak-to-peak, positive peak or negative peak level in the RECEIVED JITTER window.

*Note: Intrinsic jitter of the System Under Test can be measured either on data or clock signals. A spectrum analysis of the System Under Test may be observed by connecting a Spectrum Analyzer (eg HP 3580A) to the rear-panel DEMODULATED OUTPUT. An RMS Voltmeter (eg HP 3400A) can be connected to the rear-panel DEMODULATED OUTPUT to measure rms jitter amplitude.*

**LOWER LIMIT OF MAX. TOLERABLE INPUT JITTER**  
The sinusoidal jitter applied to the interface point conforms to the Jitter Amplitude/Frequency Masks defined by CCITT (Bell) Rec. G. Series. The 3785B has these masks hard programmed.

#### Procedure

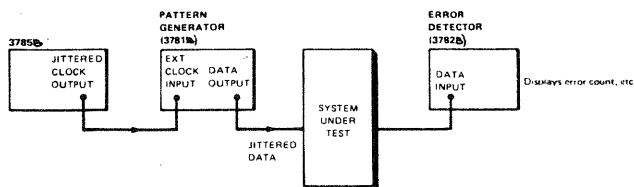

1. Connect the equipment to the desired points of interest (CCITT Reg. G703 BELL Interfaces) of the System Under Test.
2. Ensure the JITTER APPLICATION CLOCK push-button LED is illuminated.
3. Select the appropriate clock rate by pressing the desired GENERATOR CLOCK RATE push-button (check LED illuminates).
4. The hard-programmed jitter masks may be swept either automatically or manually.
5. To perform an automatic sweep, press the AUTO push-button (check LED illuminates). This initializes the jitter tolerance mask to the start position and the 3785B will automatically sweep through the jitter mask on a continuous basis.
6. To perform a manual sweep, press the MANUAL push-button (check LED illuminates) and rotate the MANUAL control. The frequency and level of the internal jitter tolerance mask can be observed in the GENERATED JITTER displays.
7. The Error Detector will detect any errors in transmission – indicating a failure of the System Under Test to tolerate the applied jitter.

**UPPER LIMIT OF MAX. TOLERABLE INPUT JITTER**  
This is the maximum sinusoidal jitter that can be applied to an interface point before errors occur in transmission (due to jitter). The 3785B Generator section applies the

required jitter and an Error Detector (eg HP 3782B) is used to detect errors in the transmitted data.

#### (MULTIPLEX JITTER TOLERANCE MEASUREMENT) Procedure

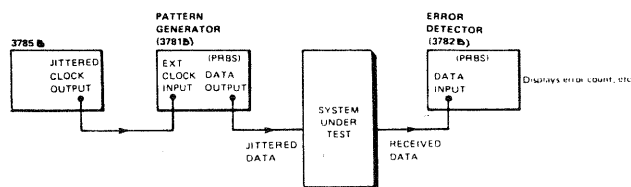

1. Connect the equipment to the desired points of interest (CCITT Rec. G703 BELL Interfaces) of the System Under Test.
2. Ensure the JITTER APPLICATION CLOCK push-button LED is illuminated.
3. Select the appropriate clock rate by pressing the desired GENERATOR CLOCK RATE push-button (check LED illuminates).
4. The jitter frequency can be adjusted by pressing the SET FREQUENCY push-button (check LED illuminates) and rotating the MANUAL control. The frequency can be observed in the GENERATED JITTER Frequency display.
5. The jitter amplitude can be adjusted by pressing the SET AMPLITUDE push-button (check LED illuminates) and rotating the MANUAL control. The amplitude can be observed in the GENERATED JITTER Amplitude display.
6. The Error Detector will detect any errors in transmission, thus indicating a failure of the system to tolerate the applied jitter.
7. The jitter amplitude should be increased until an error just occurs for that specific frequency.
8. The frequency should be changed and the amplitude adjusted until an error just occurs.
9. The resulting frequency/amplitude results can thus be plotted – indicating the system response.

**(DEMULTIPLEX JITTER TOLERANCE MEASUREMENT)  
Procedure**

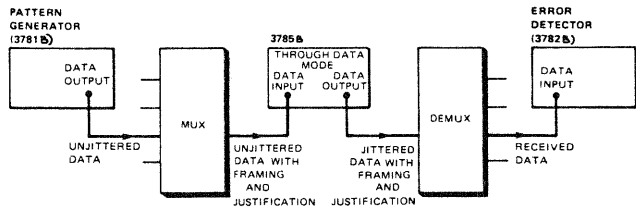

1. Connect the equipment to the desired points of interest (CCITT Rec. G703 BELL Interfaces) of the System Under Test, with the 3785B between the MUX Output and DEMUX Input.
2. Press the JITTER APPLICATION THROUGH DATA push-button (check LED illuminates).
3. Jitter can be applied to the MUX Output data signal, providing a jittered data signal for application to the DEMUX Input. This jitter signal can be applied in accordance with the CCITT (BELL) Rec. G. Series jitter tolerance masks or applied at 'spot' frequencies and levels.
4. To apply jitter in accordance with the CCITT (BELL) Rec. G. Series jitter tolerance masks, select the desired clock rate by pressing the GENERATOR and RECEIVER CLOCK RATE push-buttons (set to the same clock rate). To perform a manual sweep, press the MANUAL push-button and rotate the MANUAL control. The change in frequency and level will be displayed in the GENERATED JITTER Frequency and Amplitude windows. To perform an automatic sweep, press the AUTO push-button (check LED illuminates). The automatic change in frequency and amplitude will be displayed in the GENERATED JITTER Frequency and Amplitude windows.
5. To apply jitter at 'spot' frequencies and levels, press the SET FREQUENCY push-button (check LED illuminates) and, observing the GENERATED JITTER Frequency display, adjust the frequency using the MANUAL control. Press the SET AMPLITUDE push-button (check LED illuminates) and, observing the GENERATED JITTER Amplitude display, adjust the level using the MANUAL control.
6. Errors will be displayed by the Error Detector – giving an indication of the jitter tolerance of the DEMUX.

**JITTER TRANSFER FUNCTION**

The Jitter Transfer Function is a measurement of the jitter gain over the System Under Test, with sinusoidal jitter applied.

**(WIDEBAND)  
Procedure**

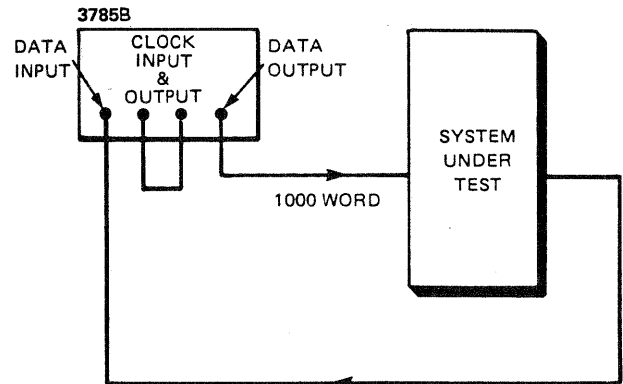

1. Connect the equipment to the desired points of interest (CCITT Rec. G703 BELL Interfaces) of the System Under Test.
2. Connect the CLOCK OUTPUT to the CLOCK INPUT, select the appropriate GENERATOR and RECEIVER CLOCK RATES and press the JITTER APPLICATION CLOCK push-button (check LED illuminates). Check the CLOCK INPUT LED illuminates.
3. Press the SET AMPLITUDE push-button (check LED illuminates) and, using the MANUAL control, set-up a RECEIVED JITTER display reading (normally less than 1 UI p-p). Take a note of this value as it is a more accurate measurement of the applied jitter than that given by the GENERATED JITTER display reading. (Use RANGE 1 for this check.)
4. Press the JITTER APPLICATION, 1000 WORD push-button (check LED illuminates).
5. Press the SET FREQUENCY push-button (check LED illuminates) and, using the MANUAL control, adjust the frequency to the desired values. Note the reading of the RECEIVED JITTER display for all the desired frequencies.
7. The ratio of these RECEIVED JITTER values to the value of RECEIVED JITTER recorded in Step 3 gives the jitter transfer function of the System Under Test.

(SELECTIVE)  
Procedure

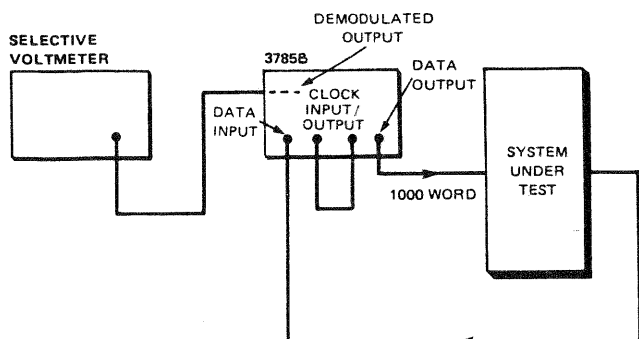

1. Connect the equipment to the desired points of interest (CCITT Rec. G703 BELL Interfaces) of the System Under Test.
2. Connect the CLOCK OUTPUT to the CLOCK INPUT, select the appropriate GENERATOR and RECEIVER CLOCK RATES and press the JITTER APPLICATION CLOCK push-button (check LED illuminates). Check the CLOCK INPUT LED illuminates.
3. Press the SET FREQUENCY push-button (check LED illuminates) and, using the MANUAL control, set the GENERATED JITTER Frequency display to a low reference frequency (approx 20Hz).
4. Press the SET AMPLITUDE push-button (check LED illuminates) and, using the MANUAL control, set-up a RECEIVED JITTER display reading (normally less than 1 UI p-p).
5. Tune the Selective Voltmeter to this frequency and adjust the input level for a reading of 0dB (this is the reference setting).
6. Press the JITTER APPLICATION 1000 WORD push-button (check LED illuminates).
7. Press the SET FREQUENCY push-button (check LED illuminates) and, using the MANUAL control, adjust the frequency to any desired value.
8. Tune the Selective Voltmeter to the same frequency.

9. The relative value of the jitter transfer function at that frequency can thus be read directly (in dB) from the Selective Voltmeter.
10. Continue to adjust the jitter modulating frequency and tune the Selective Voltmeter until all the desired points on the jitter transfer function have been plotted.

(FOR A DEMUX)  
Procedure

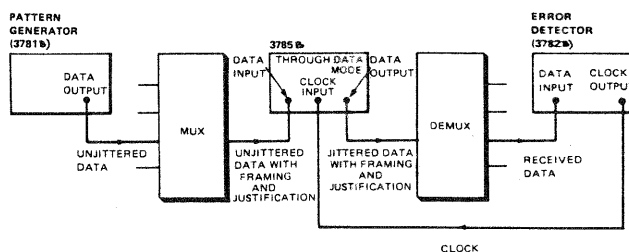

1. Connect the equipment to the points of interest (CCITT Rec. G703 BELL Interfaces) of the System Under Test, with the 3785B between the MUX Output and DEMUX Input.
2. Using this configuration, the Jitter Transfer Function and Jitter Tolerance measurements of the Demultiplexer can be obtained.

3-27 USING AN HP-IB CONTROLLER

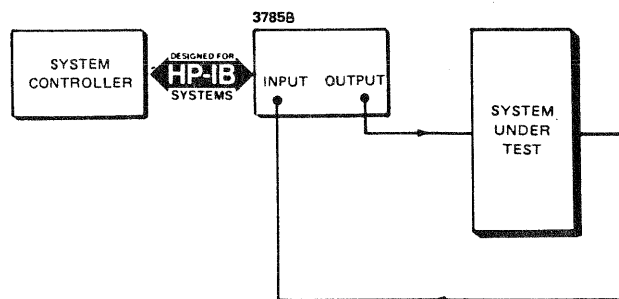

The power and flexibility of the 3785B Jitter Generator & Receiver can be greatly enhanced by connecting it to some form of external Controller via the Hewlett-Packard Interface Bus (HP-IB).

Using the configuration shown, results can be taken from the 3785B and simultaneously stored, displayed and analyzed (in real time) to some pre-determined criteria.



### 3-28 HEWLETT-PACKARD INTERFACE BUS

#### 3-29 HP-IB MODES OF OPERATION

3-30 The 3785B is designed to operate in two distinct modes – Talk Only and Addressable. The HP-IB address is set by the rear-panel dual-in-line ADDRESS switch.

#### 3-31 Operation in the Talk Only Mode

3-32 This is the simplest mode of operation and the mode used if no Controller is connected to the HP-IB. The front-panel controls are responsive and actively control the instrument. The 3785B automatically outputs messages relevant to its operation. For example, if an HP Model 5150A Option 001 Thermal Printer were connected to the 3785B it could be used to print-out measurement results. The 3785B rear-panel HP-IB ADDRESS switch must be set to Talk Only and any Peripheral must be set to Listen Only.

#### 3-33 Operation in the Addressable Mode

3-34 Whilst in the Addressable mode, the instrument can operate either under 'local' or 'remote' control.

3-35 Under 'local' operation, the front and rear-panel controls are responsive and used to control the instrument.

3-36 Under 'remote' operation, the front and rear-panel controls are inoperative. The programming codes sent by the Controller are used to control the instrument. The displays and annunciators will change to follow the remote programming codes received.

#### 3-37 PRINCIPAL FEATURES OF HP-IB OPERATION

1. Ability to overwrite a switch or push-button position by remote control.
2. Output results in one or all of the display formats.
3. Flexibility and operational simplicity achieved using pre-programmed control flags.
4. HP-IB Bus Extenders and suitable modems may be used to increase the distance between instruments.
5. The current settings of all front and rear-panel switches or all remote switches and flags be issued.

### 3-38 IMPLEMENTATION OF HP-IB

SH1	complete capability
AH1	complete capability
T5	basic talker, serial poll, talk only mode, unaddress if MLA
TE0	no capability
L4	basic listener, unaddress if MTA
LE0	no capability
SR1	complete capability
RL1	complete capability
PP0	no capability
DC1	complete capability
DT0	no capability
C0	no capability

The Talk Only/Addressable switch on the rear panel should be set to Addressable. The ADDRESS switch must be set to the appropriate HP-IB address for the Controller.

### 3-39 REPERTOIRE OF REMOTE COMMANDS

3-40 The 'remote' commands require a code to be sent to the 3785B from the HP-IB Controller. The format of this code is a two-character, upper or lower case mnemonic which specifies the action needed or the switch to be set. Sometimes the switch mnemonic is followed by a parameter which indicates the new position of the switch. For push-button switches, this number is the position of the switch – starting with 'one' at the left-hand side of a group of push-buttons (see Figure 3-2).

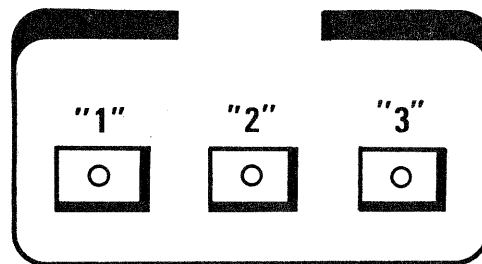

Figure 3-2 Push-button Switch Numbering

3-41 For rear-panel toggle switches, the "up" position has code '1' and the "down" position has code '2'.

3-42 Successive commands may be concatenated and may be separated by a comma (,) semi-colon (;) or space (.). Commands may be sent either whilst gating or not gating. If commands contained in Table 3-3 or LOAD command in Table 3-5 are received whilst in 'local' control, they will be accepted but ignored.





3-43 The following remote commands are available:

1. Over-write a switch or push-button on the front panel. Table 3-3 gives the switch mnemonics.

The following switches are **not** remotely controllable:

POWER (ON/OFF)  
LOCAL } Front Panel

HP-IB ADDRESS  
TALK ONLY/ADDRESSABLE } Rear Panel  
LINE VOLTAGE SELECTOR }

The rear-panel TALK ONLY FORMAT control switches are controlled instead by three control flags.

2. Remote interrogation of the status of the instrument is performed using the commands given in Table 3-4.
3. The commands required to remotely load or learn information are given in Table 3-5.

Table 3-3 Switch Mnemonics

Switch Name	Mnemonic	Parameter Range
DISPLAY RATE	DRn	$1 \leq n \leq 3$ <i>(The parameter has the following effect:                      n = 1 – selects SLOW,                      n = 2 – selects MED,                      n = 3 – selects FAST.)</i>
RANGE (UI P-P)	RAn	$1 \leq n \leq 2$ n = 1 – selects 1 n = 2 – selects 10/20
PEAK SELECT	PSn	$1 \leq n \leq 3$ <i>(The parameter has the following effect:                      n = 1 – selects P-P,                      n = 2 – selects +PK,                      n = 3 – selects -PK.)</i>
SET FREQUENCY (MODULATION)	FRn	As appropriate for clock rate in use ( <b>see Note 1</b> ).
SET AMPLITUDE (MODULATION)	AMn	As appropriate for clock rate in use ( <b>see Note 1</b> ).
EXTERNAL (MODULATION)	EXn	$1 \leq n \leq 2$ <i>(The parameter has the following effect:                      n = 1 – selects External Modulation,                      n = 2 – cancels External and returns to Internal Modulation.)</i>
MANUAL (SWEEP MASK)	MAn	As appropriate for clock rate in use ( <b>see Note 1</b> ).
AUTO (SWEEP MASK)	AUn	$1 \leq n \leq 2$ <i>(The parameter has the following effect:                      n = 1 – activates Auto Sweep                      n = 2 – cancels Auto Sweep, leaving frequency at current value.)</i>
INTERNAL (CLOCK)	IT	–
EXTERNAL (CLOCK)	ET	–
GENERATOR (CLOCK RATE)	GE <sub>n</sub>	$1 \leq n \leq 4$

(continued)



Table 3-3 Switch Mnemonics (continued)

Switch Name	Mnemonic	Parameter Range
RECEIVER (CLOCK RATE)	REn	$1 \leq n \leq 4$
DISPLAY	DIn	$1 \leq n \leq 5$ <i>The parameter has the following effect:</i> <i>n = 1 – selects HITS,</i> <i>n = 2 – selects HIT SECONDS,</i> <i>n = 3 – selects HIT FREE SECONDS,</i> <i>n = 4 – selects TIME,</i> <i>n = 5 – selects INTERVAL.)</i>
SET PEAK THRESHOLD	PTn	As appropriate for range and clock in use.
SET TIME	TIn	000000 - 235959 (Format in "HHMMSS").
SET INTERVAL	INn	000001 - 235959 (Format in "HHMMSS").
START	ST	–
STOP	SP	–
MODE	MO n	$1 \leq n \leq 3$ <i>(The parameter has the following effect:</i> <i>n = 1 – selects MAN,</i> <i>n = 2 – selects SINGLE,</i> <i>n = 3 – selects REPEAT.)</i>
JITTER APPLICATION	JAn	$1 \leq n \leq 3$
INPUT FORMAT	IFn	$1 \leq n \leq 3$ <i>(The parameter has the following effect:</i> <i>n = 1 sets to HI,</i> <i>n = 2 sets to X CON,</i> <i>n = 3 sets to MON.</i>
FILTER	FIn	$1 \leq n \leq 4$ <i>(The parameter has the following effect:</i> <i>n = 1 – selects HP1/LP,</i> <i>n = 2 – selects HP2/LP,</i> <i>n = 3 – selects LP,</i> <i>n = 4 – switches off filters.)</i>
MEASUREMENT INPUT (rear panel)	MIn	$1 \leq n \leq 2$
RECEIVER REFERENCE CLOCK (rear panel)	RCn	$1 \leq n \leq 2$
Zero Reference (display only)	ZR	Sets the generated amplitude to the zero-reference state. The reading "0 ref" is displayed in the GENERATED JITTER UI P-P window.

**Note 1:** Under 'Local' control, the rate of change of the MANUAL SWEEP control is internally limited to ensure transient-free operation of the synthesizer. Under 'Remote' control, no limit is imposed. Consequently, to operate transient free, it is recommended to impose a 20% change in frequency with any one command. An SRQ (decimal 79) can then be used to signal when the instrument is ready for a further change. This SRQ can also be used to signal when the instrument is ready for a further change following a "Set Frequency" or "Set Amplitude" command, in which case the Controller must wait for each SRQ before sending the next "Set Frequency" or "Set Amplitude" command.



Table 3-4 Interrogation Mnemonics

Interrogation Name	Mnemonic	Parameter Range
CURRENT ANSWER	CAn	<p><math>1 \leq n \leq 5</math></p> <p>There are two formats available in response to the "CAn" command.</p> <p><b>Format 1</b> – answer is formatted for transmission to a Controller.</p> <p><b>Format 2</b> – answer is formatted for transmission to a Peripheral (eg a Printer). This format is similar to Format 1 with the addition of a one or two character prefix defining the parameter being interrogated.</p> <p>Format selection is governed by the current status of Flag 1.</p> <p><i>The parameter has the following effect:</i></p> <p><i>n = 1 – Generator Frequency (see Note 1)</i>  <i>Format: Floating Point</i>  <i>Prefix: "GF"</i></p> <p><i>n = 2 – Generator Amplitude (see Note 1)</i>  <i>Format: Fixed Point</i>  <i>Prefix: "GA"</i></p> <p><i>n = 3 – Receiver Amplitude (P-P) (see Notes 1 and 2)</i>  <i>Format: Fixed Point</i>  <i>Prefix: "PP"</i>  <i>Receiver Amplitude (+P) (see Notes 1 and 2)</i>  <i>Format: Fixed Point</i>  <i>Prefix: "+P"</i>  <i>Receiver Amplitude (-P) (see Notes 1 and 2)</i>  <i>Format: Fixed Point</i>  <i>Prefix: "-P"</i></p> <p><i>n = 4 – Receiver Amplitude (MAX IN INTERVAL)</i>  <i>Format: Fixed Point</i>  <i>Prefix: "MI"</i></p> <p><i>n = 5 – Jitter Analysis (HITS)</i>  <i>Format: Fixed or Floating Point</i>  <i>Prefix: "HT"</i>  <i>Jitter Analysis (HIT SECONDS)</i>  <i>Format: Fixed or Floating Point</i>  <i>Prefix: "HS"</i>  <i>Jitter Analysis (HIT FREE SECONDS)</i>  <i>Format: Fixed or Floating Point</i>  <i>Prefix: "HF"</i>  <i>Jitter Analysis (TIME)</i>  <i>Format: String – "DDHHMMSS"</i>  <i>Prefix: "T"</i>  <i>Jitter Analysis (INTERVAL)</i>  <i>Format: String – "DDHHMMSS"</i>  <i>Prefix: "I"</i></p>
QUERY ANNUNCIATORS	QA	<p>A one byte reply is provided. Each bit is defined as follows:</p> <p>Bit 0 – Generator Clock Input. (The bit is set to '1' if the LED is illuminated.)</p> <p>Bit 1 – Receiver Data Input. (The bit is set to '1' if the LED is illuminated.)</p> <p>Bit 2 – Receiver Clock Input. (The bit is set to '1' if the LED is illuminated.)</p> <p>Bit 3 – <i>unused.</i></p> <p>Bit 4 – Receiver in/out of lock. (The bit is set to '1' if the Receiver is in lock.)</p> <p>Bit 5 – Start/Stop. (The bit is set to '1' if the annunciator is flashing.)</p> <p>Bits 6, 7 – <i>unused.</i></p>
QUERY FIRMWARE	QFn	<p><math>1 \leq n \leq 5</math></p> <p>This is a 4 byte reply giving a four-character cyclic redundancy check word (CRC). The five CRC's totally define the firmware.</p>

**Note 1:** If the particular display is blank when the command "CAn" is received by the 3785B, an answer is not available and the following messages are output as a warning:

Format 1 – "9.999E+99"  
 Format 2 – "NO ANSWER"

**Note 2:** If the particular display is showing "ERR 1" when the command "CAn" is received by the 3785B, an answer is not available and the following messages are output as a warning:

Format 1 – "9.999E+99"  
 Format 2 – "NO ANSWER"



**Table 3-5 Control Code Mnemonics**

Code Name	Mnemonic	Parameter Range
LEARN	LN	Requests the current status of all front and rear panel switch settings and control flags. (A compact 64 byte reply is given — see Note 1.)
LOAD	LD	Sets status of all front and rear panel switch settings and control flags to the settings relating to the content of the LOAD string. (This is the inverse of the "LN" command — see Note 2.)

**Note 1:** The data issued as a result of a "LEARN" command may contain any patterns of '1s' and '0s'. It might, therefore, contain a byte of data that is equal to the ASCII carriage-return or ASCII line-feed. This might cause the Controller to terminate inputting the "LEARN" string. To guard against this possibility, it is important to configure the Controller input format not to use a C/R or L/F byte as an input terminator. Instead, the Controller may use knowledge of the string length to indicate termination.

**Note 2:** If a "LOAD" command results in SRQ 67 (decimal), due to invalid data having been sent to the 3785B, a Device Clear or Selected Device Clear must be issued as the next command. The Controller must be programmed to suppress any leading or trailing blanks in the "LOAD" string. The "LOAD" string must **not** be concatenated with any other command sent to the 3785B.

4. Issue a signal to set 'Local Lockout'.
5. Issue a signal to clear 'Local Lockout'.  
(Note: It is implicit in HP-IB protocol that this command will also cause the instrument to go 'local'.)
6. Issue an HP-IB signal to cause the instrument to clear itself and return to the default state (using Device Clear or Selected Device Clear).

*It is recommended that every program used to remotely control this instrument starts with either of these commands. A wait of 0.5 seconds should follow this command.*

**3-44 CONTROL FLAGS**

3-45 To permit flexibility in the use of this instrument, many of the important operating parameters are governed by Flags. At power-on, these flags are given default values — as specified in Table 3-6. These default values may be overwritten in the 'local' and 'remote' states of the Addressable mode. In the Talk Only mode, three of the flags are controlled by the three rear-panel TALK ONLY FORMAT CONTROL switches. Another of the flags is controlled by an internal link. The flags are programmed by the mnemonic FL followed by the parameter number.

**Table 3-6 Flag Description**

Flag Number	Meaning	Parameter Number	Default Value	
			Talk Only	Addressable
1	MESSAGE SET			
	Issue answers in Peripheral format.	1	1	2
	Issue answers in Controller format.	2		
2	<b>Not Used</b>			
3	Do not issue answers at end of gating period.	5	6	5
	Issue four answers (MAX IN INTERVAL, HITS, HIT SECONDS and HIT FREE SECONDS) automatically, at end of gating period if Flag 6 is true.	6		
4	Do not prefix messages with time.	7	See Note 1	7
	Prefix messages with time.	8		
5	Do not issue Hit Second messages automatically.	9	See Note 1	9
	Automatically issue Hit Second messages.	10		
6	*True only if one or more hits have occurred. Always true.	11	See Note 1	12
		12		
7	Do not issue general control messages.	13	14	13
	Automatically issue general control messages.	14		
8	<b>Not Used</b> Use "." as message terminator. Use "CR/LF" as message terminator.	15	See Note 2	16
		16		
9	SERVICE REQUEST SET			
	Do not SRQ on occurrence of Hit Second.	17	17	17
	SRQ on occurrence of Hit Second.	18		



**Table 3-6 Flag Description (continued)**

Flag Number	Meaning	Parameter Number	Default Value	
			Talk Only	Addressable
10	Do not SRQ at end of timed gating period.	19	19	19
	SRQ at end of timed gating period — only if Flag 6 is true.	20		
11	Do not SRQ on command syntax OK.	21	21	21
	SRQ on command syntax OK.	22		
12	Do not SRQ when Receiver data transitions are lost/regained.	23	23	23
	SRQ when Receiver data transitions are lost/regained.	24		
13	Do not SRQ when Receiver clock transitions are lost/regained.	25	25	25
	SRQ when Receiver clock transitions are lost/regained.	26		
14	Do not SRQ when Generator clock transitions are lost/regained.	27	27	27
	SRQ when Generator clock transitions are lost/regained.	28		
15	Do not SRQ when Receiver loses/regains lock.	29	29	29
	SRQ when Receiver loses/regains lock.	30		
16	Do not SRQ when LOCAL push-button pressed.	31	31	31
	SRQ when LOCAL push-button pressed.	32		
17	Do not SRQ when instrument is powered-up.	33	33	33
	SRQ when instrument is powered-up.	34		
18	Do not SRQ when a MANUAL SWEEP, SET FREQUENCY or SET AMPLITUDE command has been fully executed.	35	35	35
	SRQ when a MANUAL SWEEP, SET FREQUENCY or SET AMPLITUDE command has been fully executed.	36		
19	Do not SRQ when the mask AUTO sweep reaches a frequency extremity.	37	37	37
	SRQ when the mask AUTO sweep reaches a frequency extremity.	38		

**Note 1:** The Talk Only values of Flags 4, 5 and 6 are controlled by the rear-panel TALK ONLY FORMAT CONTROL switches. Position "1" of the switch will select the even value of the parameter number. The uppermost switch on the rear-panel TALK ONLY FORMAT CONTROL switch has no equivalent in the programmable flags.

**Note 2:** The Talk Only value of Flag 8 is controlled by a link on the following Assembly:  
 03785-60137 for Standard 3785B,  
 03785-60237 for 3785B Option 001.

**3-46 OUTPUT MESSAGES**

**3-47 Output Buffer**

3-48 The 3785B has a buffer in which output messages are stacked prior to output. It is the operator's responsibility to utilize this buffer correctly. If it is required to have a large volume of output, any peripheral connected to receive this information must be fast enough to prevent an excessive backlog of output. A backlog of up to approximately 500 characters can be handled smoothly. Beyond this limit, the 3785B will discard new data until sufficient backlog has been cleared to accept a complete line of data.

**3-49 Repertoire of Messages**

3-50 The 3785B is designed to issue a number of messages during the progress of a measurement. Each message is controlled by one or more Flags. Table 3-7 lists the messages and appropriate controlling flags.

**Table 3-7 Output Messages**

Message	Control Flag(s)
An Answer	1, 2, 3, 6
HIT SECOND Message — "HS # n"	5
"NO ANSWER" (in response to "CA" when no answer available — Peripheral format)	1
"9.999e + 99" (in response to "CA" when no answer available — Controller format)	1
"START"	7
"STOP"	7
"RUN"	7
"HOLD"	7
"R DATA OFF"	7
"R DATA ON"	7
"R CLK OFF"	7
"R CLK ON"	7
"G CLK OFF"	7
"G CLK ON"	7
"R OUT LOCK"	7
"R IN LOCK"	7
"TH SET UP"	7
"DAY n"	7
"POWER ON"	7
"SWCHS INIT"	7
Time as prefix to a message	4



### 3-51 SERVICE REQUESTS

3-52 The 3785B is designed to issue a service request (SRQ) when service from the Controller is required. Control flags govern whether each request is generated.

3-53 It is possible for a service request to be generated before the Controller has had time to service any previous requests. In such instances, the 3785B stacks the requests in an orderly manner. It makes good programming sense to keep the length of this stack as short as possible by promptly responding to requests and not issuing further commands

until the stack is empty. (However, it is not mandatory for the request to be serviced immediately if at all.) The 3785B should not receive any command (including a serial poll) 100 milliseconds before or after a serial poll of the instrument.

### 3-54 Repertoire of Service Requests

3-55 Table 3-8 lists the service request codes that are used to indicate the reason for the request. The flag number that controls each service request is also given.

**Table 3-8 Service Request Codes**

Octal	Code		Meaning	Controlling Flag
	Decimal	Hex		
001	1	01	Neutral — all OK.	—
100	64	40	A Hit-Second has occurred.	9
101	65	41	End of timed gating period.	10
102	66	42	Command syntax error in line.	see Note 1
103	67	43	Contents of a "LOAD" command are invalid or incompatible.	see Note 1
104	68	44	Command syntax of line OK.	11
105	69	45	Receiver data transitions lost.	12
106	70	46	Receiver data transitions regained.	12
107	71	47	Receiver clock transitions lost.	13
110	72	48	Receiver clock transitions regained.	13
111	73	49	Generator clock transitions lost.	14
112	74	4A	Generator clock transitions regained.	14
113	75	4B	Receiver gone out of lock.	15
114	76	4C	Receiver come into lock.	15
115	77	4D	"LOCAL" push-button pressed.	16
116	78	4E	Instrument just powered-up.	17
117	79	4F	A remote SET FREQUENCY, SET AMPLITUDE or MANUAL SWEEP command has been fully executed and another similar command can now be sent.	18
120	80	50	The mask AUTO sweep has reached the lower frequency extremity and the direction of sweep has reversed.	19
121	81	51	The mask AUTO sweep has reached the upper frequency extremity and the direction of sweep has reversed.	19

**Note 1:** SRQs 66 and 67 are not controlled by a flag. Instead, they are permanently set to cause an SRQ if an erroneous command is received.



### 3-56 LOCAL Push-button

3-57 The LOCAL push-button is situated on the 3785B front panel. The function of this control is to cause the 3785B to return to the "Local" state (manually controllable). The Controller can, however, issue a Local Lockout command – in which case, the LOCAL push-button becomes inoperative.

### 3-58 Internal Real-Time Clock

3-59 The 3785B has a built-in, crystal-controlled, real-time clock. The instrument can be programmed to prefix messages with the time from this internal clock. The format of this message is "HH-MM-SS". Peripheral devices having no internal clock of their own (eg the HP Model 5150A Option 001 Thermal Printer) can thus receive timed messages from the 3785B.

3-60 The clock can be initialized in one of three ways:

1. At device power-on, the clock is set to zero.
2. Under "Local" control (either in Talk Only or Addressable modes), the DISPLAY switch can be set to TIME and the SET TIME LED illuminated. The internal clock is stopped and the front-panel MANUAL control can be used to set the Hours and Minutes. The clock restarts whenever the DISPLAY switch is altered or the SET TIME LED is extinguished.
3. Under "Remote" control, using the command "T".

*Note: The internal clock is not affected by the "Selected Device Clear" or "Device Clear" commands. Using method 2, the seconds count is set to zero and the day count is set to one. Using method 3, the day count is set to one.*

3-61 Whenever the clock rolls over, after each 24-hour period, an output message gives the day count and an SRQ is generated under control of the flags. The total range of the clock is 99 days, 23 hours, 59 minutes and 59 seconds.

### 3-62 ERROR CODES

3-63 Certain instrument states and combinations of switch positions are invalid. These invalid combinations generate an error code in one of the displays. The significance of these codes is given in Table 3-9.

Table 3-9 Error Code Description

Error Code	Meaning	Display Used
1	The positive and negative peak displays indicate the position of the positive and negative peaks of the demodulated signal with respect to its mean. However, due to the low frequency limits of the measurement bandwidth, the instrument may require several tens of seconds to establish the mean. It is therefore possible, in a transient way, for the mean to fall outwith the range of the demodulated signal – resulting in erroneous displays. Consequently, ERROR CODE 1 is displayed instead.	"RECEIVED JITTER"
5	Code "31" not permitted for HP-IB Address.	"JITTER ANALYSIS"
6	'Talk Only' mode not permitted when Controller connected.	"JITTER ANALYSIS"
7	The instrument has been powered-up from an off or power-interrupt state, with the front-panel switch settings successfully retained in non-volatile memory. The flashing ERROR CODE 7 will cease when any switch is moved or any 'remote' command is received via the HP-IB.	"JITTER ANALYSIS"
8	Similar to ERROR CODE 7, except that the front-panel switch settings have <b>not</b> been successfully retained in non-volatile memory. Consequently, they have been set to their default values.	"JITTER ANALYSIS"



### 3-64 DEFINITION OF 'LEARN' TRANSFER

3-65 In response to a Learn command, the 3785B outputs the current settings of the switches and flags in a compact form. It is not necessary for the operator to know the internal format of this information, as its normal use is to allow a subsequent load instruction to re-load the switches and flags with their earlier values. However, Table 3-10 defines the structures — should a need arise

to know the internal structure.

3-66 Each controllable switch is allocated the bits given in Table 3-10 (undefined bits are not necessarily output as zero). The information output signal comprises 64 bytes. All switch codes start with zero at the left-hand side. *The content of the data string from a Learn command must not be modified, otherwise it will not be accepted in a subsequent Load command.*

Table 3-10 Response Codes

Switch	Byte Number	Bits	Format
Flags 1 to 19	1 - 19	0 - 7	Boolean
<i>Reserved for internal use</i>	20	-	-
Generator SET FREQUENCY	21 - 23	0 - 7	Binary Floating Point
Generator SET AMPLITUDE	24 - 26	0 - 7	Binary Floating Point
Receiver SET PEAK THRESHOLD	27 - 29	0 - 7	Binary Floating Point
<i>Reserved for internal use</i>	30 - 32	0 - 7	-
INTERVAL (SECONDS)	33	0 - 7	BCD
(MINUTES)	34	0 - 7	BCD
(HOURS)	35	0 - 7	BCD
<i>Reserved for internal use</i>	36 - 46	0 - 7	-
DISPLAY RATE	47	0 - 1	Binary
PEAK SELECT	48	0 - 1	Binary
MODULATION	49	0 - 1	Binary
GENERATOR CLOCK RATE	50	0 - 1	Binary
RECEIVER CLOCK RATE	51	0 - 1	Binary
DISPLAY	52	0 - 2	Binary
MODE	53	0 - 1	Binary
JITTER APPLICATION	54	0 - 1	Binary
INPUT FORMAT	55	0 - 1	Binary
FILTERS	56	0 - 1	Binary
RANGE UI (P-P)	57	0 - 1	Binary
MANUAL (rotary control)	58	0 - 2	Binary
CLOCK	59	0	-
'Dummy'	60	0	-
START/STOP	61	-	-
<i>Reserved for internal use</i>	62	0 - 7	-
CRC Checkword	63, 64	0 - 7	-





### 3-67 DEFAULT VALUES

3-68 The 3785B uses non-volatile, random access memory to retain the front-panel switch settings when the instrument is powered-down. There are, however, a set of default values which are sometimes used to set these switches to a pre-defined state.

3-69 The front-panel switch default values are given in Table 3-11 and these default values are invoked as defined in Table 3-12.

**Table 3-11 Default Values**

Switch	Default Value
Generator SET FREQUENCY	1 kHz
Generator SET AMPLITUDE	0.1 UI
Receiver SET PEAK THRESHOLD	10 UI
INTERVAL setting	1 minute
DISPLAY RATE	FAST
PEAK SELECT	P-P
MODULATION	de-selected
GENERATOR CLOCK RATE	DS-3
DISPLAY	TIME
RECEIVER CLOCK RATE	DS-3
MODE	MANUAL
JITTER APPLICATION	CLOCK
INPUT FORMAT	X CON
FILTERS	OFF
RANGE	20 UI
MANUAL (rotary control)	de-selected
CLOCK	INT
TERM/MON	TERM
STOP/START	STOP

### 3-70 USING THE HP 37201A BUS EXTENDER

3-71 The HP Model 37201A Bus Extender and suitable modems may be used to increase the distance between instruments. However, these long-distance communication paths must remain connected for the entire period that the instruments are expected to function remotely. Remember, that for each "local" 37201A Bus Extender used, only one "remote" 37201A Bus Extender and HP-IB instrument cluster can be active at any one time.

**Table 3-12 Default Causes/Effects**

Cause	Front-Panel Switches	Effect	
		Control Flags (Except Flag 17)	Control Flag 17
Power-up in TALK ONLY mode with non-volatile memory successfully retained.	NO	YES	YES
Power-up in TALK ONLY mode with non-volatile memory corrupted.	YES	YES	YES
Power-up in ADDRESSABLE mode with non-volatile memory successfully retained.	NO	YES	NO
Power-up in ADDRESSABLE mode with non-volatile memory corrupted.	YES	YES	YES
Upon receipt of HP-IB commands 'Device Clear' or 'Selected Device Clear'.	YES	YES	YES
A change to the rear-panel HP-IB TALK ONLY/ ADDRESSABLE or ADDRESS switches.	NO	YES	YES



# SALES & SUPPORT OFFICES

Arranged alphabetically by country

1



## Product Line Sales/Support Key

### Key Product Line

- A** Analytical
- CM** Components
- C** Computer Systems
- E** Electronic Instruments & Measurement Systems
- M** Medical Products
- P** Personal Computation Products
- \* Sales only for specific product line
- \*\* Support only for specific product line

**IMPORTANT:** These symbols designate general product line capability. They do not insure sales or support availability for all products within a line, at all locations. Contact your local sales office for information regarding locations where HP support is available for specific products.

## HEADQUARTERS OFFICES

If there is no sales office listed for your area, contact one of these headquarters offices.

### NORTH/CENTRAL AFRICA

Hewlett-Packard S.A.  
7, rue du Bois-du-Lan  
CH-1217 MEYRIN 1, Switzerland  
Tel: (022) 83 12 12  
Telex: 27835 hmea  
Cable: HEWPACKSA Geneve

### ASIA

Hewlett-Packard Asia Ltd.  
47/F, 26 Harbour Rd.,  
Wanchai, HONG KONG  
G.P.O. Box 863, Hong Kong  
Tel: 5-8330833  
Telex: 76793 HPA HX  
Cable: HPASIAL TD

### CANADA

Hewlett-Packard (Canada) Ltd.  
6877 Goreway Drive  
MISSISSAUGA, Ontario L4V 1M8  
Tel: (416) 678-9430  
Telex: 610-492-4246

### EASTERN EUROPE

Hewlett-Packard Ges.m.b.h.  
Lieblgasse 1  
P.O.Box 72  
A-1222 VIENNA, Austria  
Tel: (222) 2500-0  
Telex: 1 3 4425 HEPA A

### NORTHERN EUROPE

Hewlett-Packard S.A.  
Uilenstede 475  
P.O.Box 999  
NL-1183 AG AMSTELVEEN  
The Netherlands  
Tel: 20 43777 1  
Telex: 18 919 hpnr nl

### SOUTH EAST EUROPE

Hewlett-Packard S.A.  
World Trade Center  
110 Avenue Louis Casai  
1215 Cointrin, GENEVA, Switzerland  
Tel: (022) 98 96 51  
Telex: 27225 hpser

### MEDITERRANEAN AND MIDDLE EAST

Hewlett-Packard S.A.  
Mediterranean and Middle East  
Operations  
Atrina Centre  
32 Kifissias Ave.  
Paradisos-Amarousion, ATHENS  
Greece  
Tel: 682 88 11  
Telex: 21-6588 HPAT GR  
Cable: HEWPACKSA Athens

### UNITED KINGDOM

Hewlett-Packard Ltd.  
Nine Mile Ride  
Easthampstead, WOKINGHAM  
Berkshire, IRG11 3LL  
Tel: 0344 773100  
Telex: 848805

### EASTERN USA

Hewlett-Packard Co.  
4 Choke Cherry Road  
ROCKVILLE, MD 20850  
Tel: (301) 258-2000

### MIDWESTERN USA

Hewlett-Packard Co.  
5201 Tollview Drive  
ROLLING MEADOWS, IL 60008  
Tel: (312) 255-9800

### SOUTHERN USA

Hewlett-Packard Co.  
2000 South Park Place  
P.O. Box 105005  
ATLANTA, GA 30348  
Tel: (404) 955-1500

### WESTERN USA

Hewlett-Packard Co.  
3939 Lankershim Blvd.  
P.O. Box 3919  
LOS ANGELES, CA 91604  
Tel: (213) 506-3700

### OTHER INTERNATIONAL AREAS

Hewlett-Packard Co.  
Intercontinental Headquarters  
3495 Deer Creek Road  
PALO ALTO, CA 94304  
Tel: (415) 857-1501  
Telex: 034-8300  
Cable: HEWPACK

### ANGOLA

Telectra Angola LDA  
Empresa Técnica de Equipamentos  
Rua Conselheiro Julio de Vilhena, 16  
Caixa Postal 6487  
LUANDA  
Tel: 35515,35516  
Telex: 3134  
E.C.\*

### ARGENTINA

Hewlett-Packard Argentina S.A.  
Montaneses 2140/50  
1428 BUENOS AIRES  
Tel: 783-4886/4836/4730  
Cable: HEWPACKARG  
A,C,CM,E,P  
Biotron S.A.C.I.e.L  
Av. Paso Colon 221, Piso 9  
1399 BUENOS AIRES  
CM

Laboratorio Rodriguez  
Corswant S.R.L.  
Misiones, 1156 - 1876  
Bernal, Oeste  
BUENOS AIRES  
Tel: 252-3958, 252-4991  
A

Argentina Esanco S.R.L.  
Avasco 2328  
1416 BUENOS AIRES  
Tel: 541-58-1981, 541-59-2767  
A

### AUSTRALIA

#### Adelaide, South Australia Office

Hewlett-Packard Australia Ltd.  
153 Greenhill Road  
PARKSIDE, S.A. 5063  
Tel: 272-5911  
Telex: 82536  
Cable: HEWPARD Adelaide  
A\*,C,CM,E,M,P

#### Brisbane, Queensland Office

Hewlett-Packard Australia Ltd.  
10 Payne Road  
THE GAP, Queensland 4061  
Tel: 30-4133  
Telex: 42133  
Cable: HEWPARD Brisbane  
A,C,CM,E,M,P

### Canberra, Australia Capital Territory Office

Hewlett-Packard Australia Ltd.  
121 Wollongong Street  
FYSHWICK, A.C.T. 2609  
Tel: 80 4244  
Telex: 62650  
Cable: HEWPARD Canberra  
C,CM,E,P

### Melbourne, Victoria Office

Hewlett-Packard Australia Ltd.  
31-41 Joseph Street  
BLACKBURN, Victoria 3130  
Tel: 895-2895  
Telex: 31-024  
Cable: HEWPARD Melbourne  
A,C,CM,E,M,P

### Perth, Western Australia Office

Hewlett-Packard Australia Ltd.  
261 Stirling Highway  
CLAREMONT, W.A. 6010  
Tel: 383-2188  
Telex: 93859  
Cable: HEWPARD Perth  
A,C,CM,E,M,P

### Sydney, New South Wales Office

Hewlett-Packard Australia Ltd.  
17-23 Talavera Road  
P.O. Box 308  
NORTH RYDE, N.S.W. 2113  
Tel: 888-4444  
Telex: 21561  
Cable: HEWPARD Sydney  
A,C,CM,E,M,P

### AUSTRIA

Hewlett-Packard Ges.m.b.h.  
Verkausbüro Graz  
Grottenhofstrasse 94  
A-8052 GRAZ  
Tel: (0316) 291 56 60  
Telex: 32375  
C,E

Hewlett-Packard Ges.m.b.h.  
Lieblgasse 1  
P.O. Box 72  
A-1222 VIENNA  
Tel: (0222) 2500-0  
Telex: 134425 HEPA A  
A,C,CM,E,M,P

### BAHRAIN

Green Salon  
P.O. Box 557  
MANAMA  
Tel: 255503-255950  
Telex: 8441  
P

Wael Pharmacy  
P.O. Box 648  
MANAMA  
Tel: 256123  
Telex: 8550 WAEL BN  
E,M

Zayani Computer Systems  
218 Shaik Mubarak Building  
Government Avenue  
P.O. Box 5918  
MANAMA  
Tel: 276278  
Telex: 9015  
P

### BELGIUM

Hewlett-Packard Belgium S.A./N.V.  
Blvd de la Woluwe, 100  
Woluwedal  
B-1200 BRUSSELS  
Tel: (02) 762-32-00  
Telex: 23-494 paloben bru  
A,C,CM,E,M,P

### BERMUDA

Applied Computer Technologies  
Atlantic House Building  
Par-La-Ville Road  
Hamilton 5  
Tel: 295-1616  
P

### BRAZIL

Hewlett-Packard do Brasil  
I.e.C. Ltda.  
Alameda Rio Negro, 750  
Alphaville  
06400 BARUERI SP  
Tel: (011) 421.1311  
Telex: (011) 33872 HPBR-BR  
Cable: HEWPACK Sao Paulo  
A,C,CM,E,M,P  
  
Hewlett-Packard do Brasil  
I.e.C. Ltda.  
Praia de Botafogo 228  
6º Andar-conj 614  
Edificio Argentina - Ala A  
22250 RIO DE JANEIRO  
Tel: (021) 552-6422  
Telex: 21905 HPBR-BR  
Cable: HEWPACK Rio de Janeiro  
A,C,CM,E,P\*

Convex/Van Den  
Rua Jose Bonifacio  
458 Todos Os Santos  
CEP 20771  
RIO DE JANEIRO, RJ  
Tel: 591-0197  
Telex: 33487 EGLB BR  
A

ANAMED I.C.E.I. Ltda.  
Rua Bage, 103  
04012 SAO PAULO, SP  
Tel: (011) 572-6537  
Telex: 24720 HPBR-BR  
M

Datatronix Electronica Ltda.  
Av. Pacaembu 746-C11  
SAO PAULO, SP  
Tel: (118) 260111  
CM

### CAMEROON

Beric  
B. P. 23  
DOUALA  
Tel: 420153  
Telex: 5351  
C,P

### CANADA

Alberta  
Hewlett-Packard (Canada) Ltd.  
3030 3rd Avenue N.E.  
CALGARY, Alberta T2A 6T7  
Tel: (403) 235-3100  
A,C,CM,E\*,M,P\*

Hewlett-Packard (Canada) Ltd.  
11120-178th Street  
EDMONTON, Alberta T5S 1P2  
Tel: (403) 486-6666  
A,C,CM,E,M,P



# SALES & SUPPORT OFFICES

Arranged alphabetically by country

## CANADA (Cont'd)

### British Columbia

Hewlett-Packard (Canada) Ltd.  
10691 Shellbridge Way

### RICHMOND,

British Columbia V6X 2W7  
Tel: (604) 270-2277  
Telex: 610-922-5059  
A.C.C.M.E.\*.M.P.\*

Hewlett-Packard (Canada) Ltd.  
121 - 3350 Douglas Street

**VICTORIA**, British Columbia V8Z 3L1  
Tel: (604) 381-6616  
C

### Manitoba

Hewlett-Packard (Canada) Ltd.  
1825 Inkster Blvd.  
**WINNIPEG**, Manitoba R2X 1R3  
Tel: (204) 694-2777  
A.C.C.M.E.\*.M.P.\*

### New Brunswick

Hewlett-Packard (Canada) Ltd.  
814 Main Street  
**MONCTON**, New Brunswick E1C 1E6  
Tel: (506) 855-2841  
C

### Nova Scotia

Hewlett-Packard (Canada) Ltd.  
Suite 111  
900 Windmill Road  
**DARTMOUTH**, Nova Scotia B3B 1P7  
Tel: (902) 469-7820  
C.C.M.E.\*.M.P.\*

### Ontario

Hewlett-Packard (Canada) Ltd.  
3325 N. Service Rd., Unit 3  
**BURLINGTON**, Ontario L7N 3G2  
Tel: (416) 335-8644  
C.M.\*

Hewlett-Packard (Canada) Ltd.  
496 Days Road  
**KINGSTON**, Ontario K7M 5R4  
Tel: (613) 384-2088  
C

Hewlett-Packard (Canada) Ltd.  
552 Newbold Street  
**LONDON**, Ontario N6E 2S5  
Tel: (519) 686-9181  
A.C.C.M.E.\*.M.P.\*

Hewlett-Packard (Canada) Ltd.  
6877 Goreway Drive  
**MISSISSAUGA**, Ontario L4V 1M8  
Tel: (416) 678-9430  
A.C.C.M.E.\*.M.P.

Hewlett-Packard (Canada) Ltd.  
2670 Queensview Dr.  
**OTTAWA**, Ontario K2B 8K1  
Tel: (613) 820-6483  
A.C.C.M.E.\*.M.P.\*

Hewlett-Packard (Canada) Ltd.  
The Oaks Plaza, Unit #9  
2140 Regent Street  
**SUDBURY**, Ontario, P3E 5S8  
Tel: (705) 522-0202  
C

Hewlett-Packard (Canada) Ltd.  
3790 Victoria Park Ave.  
**WILLOWDALE**, Ontario M2H 3H7  
Tel: (416) 499-2550  
C

## Quebec

Hewlett-Packard (Canada) Ltd.  
17500 Trans Canada Highway  
South Service Road  
**KIRKLAND**, Quebec H9J 2X8  
Tel: (514) 697-4232  
A.C.C.M.E.\*.M.P.\*

Hewlett-Packard (Canada) Ltd.  
1150 rue Claire Fontaine  
**QUEBEC CITY**, Quebec G1R 5G4  
Tel: (418) 648-0726  
C

Hewlett-Packard (Canada) Ltd.  
130 Robin Crescent  
**SASKATOON**, Saskatchewan S7L 6M7  
Tel: (306) 242-3702  
C

## CHILE

ASC Ltda.  
Austria 2041  
**SANTIAGO**  
Tel: 223-5946, 223-6148  
Telex: 340192 ASC CK  
C.P

Isical Ltda.  
Av. Italia 634 Santiago  
Casilla 16475  
**SANTIAGO** 9  
Tel: 222-0222  
Telex: 440283 JCYCL CZ  
C.M.E.M

Metrolab S.A.  
Monjitas 454 of. 206  
**SANTIAGO**  
Tel: 395752, 398296  
Telex: 340866 METLAB CK  
A

Olympia (Chile) Ltda.  
Av. Rodrigo de Araya 1045  
Casilla 256-V  
**SANTIAGO** 21  
Tel: 225-5044  
Telex: 340892 OLYMP  
Cable: Olympichile Santiagochile  
C,P

## CHINA, People's Republic of

China Hewlett-Packard, Ltd.  
47/F China Resources Bldg.  
26 Harbour Road  
**HONG KONG**  
Tel: 5-8330833  
Telex: 76793 HPA HX  
Cable: HP ASIA LTD  
A\*.M.\*

China Hewlett-Packard, Ltd.  
P.O. Box 9610, Beijing  
4th Floor, 2nd Watch Factory Main Bldg.  
Shuang Yu Shu, Bei San Huan Rd.  
Hai Dian District  
**BEIJING**  
Tel: 28-0567  
Telex: 22601 CTSHP CN  
Cable: 1920 Beijing  
A.C.C.M.E.\*.M.P.

## COLOMBIA

Instrumentación  
H. A. Langebaek & Kier S.A.  
Carrera 4A No. 52A-26  
Apartado Aereo 6287  
**BOGOTA** 1, D.E.  
Tel: 212-1466  
Telex: 44400 INST CO  
Cable: AARIS Bogota  
C.M.E.M

Nefromedicas Ltda.  
Calle 123 No. 9B-31  
Apartado Aereo 100-958  
**BOGOTA** D.E., 10  
Tel: 213-5267, 213-1615  
Telex: 43415 HEGAS CO  
A

Compumundo  
Avenida 15 # 107-80  
**BOGOTA** D.E.  
Tel: 214-4458  
Telex: 45466 MARICO  
P

Carvajal, S.A.  
Calle 29 Norte No. 6A-40  
Apartado Aereo 46  
**CALI**  
Tel: 368-1111  
Telex: 55650  
C.E.P

## CONGO

Seric-Congo  
B. P. 2105  
**BRAZZAVILLE**  
Tel: 815034  
Telex: 5262

## COSTA RICA

Cientifica Costarricense S.A.  
Avenida 2, Calle 5  
San Pedro de Montes de Oca  
Apartado 10159  
**SAN JOSÉ**  
Tel: 24-38-20, 24-08-19  
Telex: 2367 GALGUR CR  
C.M.E.M

## CYPRUS

Telerexa Ltd.  
P.O. Box 4809  
14C Stassinou Avenue  
**NICOSIA**  
Tel: 62698  
Telex: 2894 LEVIDO CY  
E.M,P

## DENMARK

Hewlett-Packard A/S  
Datavej 52  
DK-3460 **BIRKEROD**  
Tel: (02) 61-66-40  
Telex: 37409 hpas dk  
A.C.C.M.E.\*.M.P.

Hewlett-Packard A/S  
Rølgædsvej 32  
DK-8240 **RISSKOV**, Aarhus  
Tel: (06) 17-60-00  
Telex: 37409 hpas dk  
C.E

## DOMINICAN REPUBLIC

Microprog S.A.  
Juan Tomás Mejía y Cotes No. 60  
Arroyo Hondo  
**SANTO DOMINGO**  
Tel: 565-6268  
Telex: 4510 ARENTA DR (RCA)  
P

## ECUADOR

CYEDE Cia. Ltda.  
Avenida Eloy Alfaro 1749  
y Belgica  
Casilla 6423 CCI  
**QUITO**  
Tel: 450-975, 243-052  
Telex: 22548 CYEDE ED  
C.M.E.P

Medtronics  
Valladolid 524 Madrid  
P.O. 9171, **QUITO**  
Tel: 223-8951  
Telex: 2298 ECKAME ED  
A

Hospitalar S.A.  
Robles 625  
Casilla 3590  
**QUITO**  
Tel: 545-250, 545-122  
Telex: 2485 HOSP TL ED  
Cable: HOSPITALAR-Quito  
M

Ecuador Overseas Agencies C.A.  
Calle 9 de Octubre #818  
P.O. Box 1296, Guayaquil  
**QUITO**  
Tel: 306022  
Telex: 3361 PBCGYE ED  
M

## EGYPT

Sakrcro Enterprises  
70, Mossadak Str.  
Dokki, Giza  
**CAIRO**  
Tel: 706440  
Telex: 93146  
C

International Engineering Associates  
24 Hussein Hegazi Street  
Kasr-el-Ain  
**CAIRO**  
Tel: 23829, 21641  
Telex: 93830 IEA UN  
Cable: INTEGASSO  
E.M.\*

S.S.C. Medical  
Centre d'affaires Paris-Nord  
Mohandessin  
**CAIRO**  
Tel: 803844, 805998, 810263  
Telex: 20503 SSC UN  
M.\*

## EL SALVADOR

IPESA de El Salvador S.A.  
29 Avenida Norte 1223  
**SAN SALVADOR**  
Tel: 26-6858, 26-6868  
Telex: 20539 IPESA SAL  
A.C.C.M.E.P

## ETHIOPIA

Seric-Ethiopia  
P.O. Box 2764  
**ADDIS ABABA**  
Tel: 185114  
Telex: 21150  
C,P

## FINLAND

Hewlett-Packard Oy  
Piispankalliontie 17  
02200 **ESPOO**  
Tel: 00358-0-88721  
Telex: 121563 HEWPA SF  
A.C.C.M.E.\*.M.P

## FRANCE

Hewlett-Packard France  
Z.I. Mercure B  
Rue Berthelot  
13763 Les Milles Cedex  
**AIX-EN-PROVENCE**  
Tel: (42) 59-41-02  
Telex: 410770F  
A.C.E.M.P.\*

Hewlett-Packard France  
64, rue Marchand Saillant  
61000 **ALENCON**  
Tel: (33) 29 04 42

Hewlett-Packard France  
28 rue de la République  
Boite Postale 503  
25026 **BESANCON** Cedex  
Tel: (81) 83-16-22  
Telex: 361157  
C.M

Hewlett-Packard France  
Chemin des Mouilles  
Boite Postale 162  
69130 **ECULLY** Cedex (Lyon)  
Tel: (78) 833-81-25  
Telex: 310617F  
A.C.E.M

Hewlett-Packard France  
Parc d'activités du Bois Briard  
2, avenue du Lac  
91040 **EVRY** Cedex  
Tel: 6 077-96 60  
Telex: 692315F  
E

Hewlett-Packard France  
5, avenue Raymond Chanas  
38320 **EYBENS** (Grenoble)  
Tel: (76) 62-57-98  
Telex: 980124 HP GRENOB EYBE  
C

Hewlett-Packard France  
Rue Fernand Forest  
Z.A. Kergaradec  
29239 **GOUENNOU**  
Tel: (98) 41-87-90

Hewlett-Packard France  
Centre d'affaires Paris-Nord  
Bâtiment Ampère  
Rue de la Commune de Paris  
Boite Postale 300  
93153 **LE BLANC-MESNIL**  
Tel: (1) 865-44-52  
Telex: 211032F  
C.E.M

Hewlett-Packard France  
Parc d'activités Cadera  
Quartier Jean-Mermoz  
Avenue du Président J.F. Kennedy  
F-33700 **MERIGNAC** (Bordeaux)  
Tel: (56) 34-00-84  
Telex: 550105F  
C.E.M

Hewlett-Packard France  
Immueble "Les 3 B"  
Nouveau chemin de la Garde  
ZAC du Bois Briard  
44085 **NANTES** Cedex  
Tel: (40) 50-32-22  
Telex: 711085F  
C\*\*

Hewlett-Packard France  
125, rue du Faubourg Banner  
45000 **ORLEANS**  
Tel: (38) 68 01 63



## FRANCE (Cont'd)

Hewlett-Packard France  
Zone Industrielle de Courtaboeuf  
Avenue des Tropiques  
91947 Les Ulis Cedex **ORSAY**  
Tel: (6) 907-78-25  
Telex: 600048F  
A,C,CM,E,M,P

Hewlett-Packard France  
Paris Porte-Maillot  
15, boulevard de L'Amiral-Bruix  
75782 **PARIS** Cedex 16  
Tel: (1) 502-12-20  
Telex: 613663F  
C,M,P

Hewlett-Packard France  
124, Boulevard Touraine  
64000 **PAU**  
Tel: (59) 80 38 02

Hewlett-Packard France  
2 Allée de la Bourgonnette  
35100 **RENNES**  
Tel: (99) 51-42-44  
Telex: 740912F  
C,CM,E,M,P\*

Hewlett-Packard France  
98 avenue de Bretagne  
76100 **ROUEN**  
Tel: (35) 63-57-66  
Telex: 770035F  
C

Hewlett-Packard France  
4, rue Thomas-Mann  
Boite Postale 56  
67033 **STRASBOURG** Cedex  
Tel: (88) 28-56-46  
Telex: 890141F  
C,E,M,P\*

Hewlett-Packard France  
La Pérépole III  
20, chemin du Pigeonnier de la Cèpière  
F-31083 **TOULOUSE** Cedex  
Tel: (61) 40-11-12  
Telex: 531639F  
A,C,E,P\*

Hewlett-Packard France  
9, rue Baudin  
26000 **VALENCE**  
Tel: (75) 42 76 16

Hewlett-Packard France  
Carolor  
ZAC de Bois Briand  
57640 **VIGY** (Metz)  
Tel: (8) 771 20 22  
C

Hewlett-Packard France  
Parc d'activité des Prés  
1, rue Papin  
59658 **VILLENEUVE D'ASCQ** Cedex  
Tel: (20) 47 78 78  
Telex: 160124F  
C,E,M,P\*

## GABON

Sho Gabon  
P.O. Box 89  
**LIBREVILLE**  
Tel: 721 484  
Telex: 5230

## GERMAN FEDERAL REPUBLIC

Hewlett-Packard GmbH  
Geschäftsstelle  
Keithstrasse 2-4  
D-1000 **BERLIN** 30  
Tel: (030) 21 99 04-0  
Telex: 018 3405 hpbln d  
A,C,E,M,P

Hewlett-Packard GmbH  
Vertriebszentrum Südwest  
Schickardstrasse 2  
D-7030 **BÖBLINGEN**  
Tel: (07031) 645-0  
Telex: 7265 743 hep  
A,C,CM,E,M,P

Hewlett-Packard GmbH  
Vertriebszentrum West  
Berliner Strasse III  
D-4030 **RATINGEN** 3  
Tel: (02102) 494-0  
Telex: 589 070 hprad  
A,C,E,M,P

Hewlett-Packard GmbH  
Geschäftsstelle  
Schleefstr. 28a  
D-4600 **DORTMUND**-41  
Tel: (0231) 45001  
Telex: 822858 hepdad  
A,C,E

Hewlett-Packard GmbH  
Vertriebszentrum Mitte  
Hewlett-Packard-Strasse  
D-6380 **BAD HOMBURG**  
Tel: (06172) 400-0  
Telex: 410 844 hpbhg  
A,C,E,M,P

Hewlett-Packard GmbH  
Vertriebszentrum Nord  
Kapsdtring 5  
D-2000 **HAMBURG** 60  
Tel: (040) 63804-1  
Telex: 021 63 032 hphh d  
A,C,E,M,P

Hewlett-Packard GmbH  
Geschäftsstelle  
Heidering 37-39  
D-3000 **HANNOVER** 61  
Tel: (0511) 5706-0  
Telex: 092 3259  
A,C,CM,E,M,P

Hewlett-Packard GmbH  
Geschäftsstelle  
Rosslauer Weg 2-4  
D-6800 **MANNHEIM**  
Tel: (0621) 70 05-0  
Telex: 0462105  
A,C,E

Hewlett-Packard GmbH  
Geschäftsstelle  
Messerschmittstrasse 7  
D-7910 **NEU ULM**  
Tel: (0731) 70 73-0  
Telex: 0712816 HP ULM-D  
A,C,E\*

Hewlett-Packard GmbH  
Geschäftsstelle  
Emmericher Strasse 13  
D-8500 **MÜNCHEN** 10  
Tel: (0911) 5205-0  
Telex: 0623 860 hpnbg  
C,CM,E,M,P

Hewlett-Packard GmbH  
Vertriebszentrum Süd  
Eschenstrasse 5  
D-8028 **TAUFKIRCHEN**  
Tel: (089) 61 20 7-0  
Telex: 0524985  
A,C,CM,E,M,P

Hewlett-Packard GmbH  
Geschäftsstelle  
Ermisallee  
7517 **WALDBRONN** 2  
Tel: (07243) 602-0  
Telex: 782 838 hep  
A,C,E

## GREAT BRITAIN

See United Kingdom

## GREECE

Hewlett-Packard A.E.  
178, Kifissias Avenue  
6th Floor  
Halandri-**ATHENS**  
Greece  
Tel: 6471543, 6471673, 6472971  
Telex: 221 286 HPHLGR  
A,C,CM\*\*,E,M,P

Kostas Karayannis S.A.  
8, Omirou Street  
**ATHENS** 133  
Tel: 32 30 303, 32 37 371  
Telex: 215962 RKAR GR  
A,C\*,CM,E

Impexin  
Intelect Div.  
209 Mesogion  
11525 **ATHENS**  
Tel: 6474481/2  
Telex: 216286  
P

Haril Company  
38, Mihalakopoulou  
**ATHENS** 612  
Tel: 7236071  
Telex: 218767  
M\*

Hellamco  
P.O. Box 87528  
18507 **PIRAEUS**  
Tel: 4827049  
Telex: 241441  
A

## GUATEMALA

IPESA  
Avenida Reforma 3-48, Zona 9  
**GUATEMALA CITY**  
Tel: 316627, 314786  
Telex: 3055765 IPESA GU  
A,C,CM,E,M,P

## HONG KONG

Hewlett-Packard Hong Kong, Ltd.  
G.P.O. Box 795  
5th Floor, Sun Hung Kai Centre  
30 Harbour Road  
**HONG KONG**  
Tel: 5-8323211  
Telex: 66678 HEWPA HX  
Cable: HEWPACK Hong Kong  
E,C,P

CET Ltd.  
10th Floor, Hua Asia Bldg.  
64-66 Gloucester Road  
**HONG KONG**  
Tel: (5) 200922  
Telex: 85148 CET HX  
CM

Schmidt & Co. (Hong Kong) Ltd.  
18th Floor, Great Eagle Centre  
23 Harbour Road  
**HONG KONG**  
Tel: 5-8330222  
Telex: 74766 SCHMC HX  
A,M

## ICELAND

Hewlett-Packard Iceland  
Hoeðabakka 9  
110 **Reykjavik**  
Tel: (1) 67 1000  
A,C,CM,E,M,P

## INDIA

Computer products are sold through  
Blue Star Ltd. All computer repairs and  
maintenance service is done through  
Computer Maintenance Corp.

Blue Star Ltd.  
Sabri Complex 2nd Floor  
24 Residency Rd.  
**BANGALORE** 560 025  
Tel: 55660, 578881  
Telex: 0845-430  
Cable: BLUESTAR  
A,C\*,CM,E

Blue Star Ltd.  
Band Box House  
Prabhadevi  
**BOMBAY** 400 025  
Tel: 4933101, 4933222  
Telex: 011-71051  
Cable: BLUESTAR  
A,M

Blue Star Ltd.  
Sahas  
414/2 Vir Savarkar Marg  
Prabhadevi  
**BOMBAY** 400 025  
Tel: 422-6155, 422-6556  
Telex: 011-71193 BSSS IN  
Cable: FROSTBLUE  
A,C\*,CM,E,M

Blue Star Ltd.  
Kalyan, 19 Vishwas Colony  
Alkapuri, **BORODA**, 390 005  
Tel: 65235, 65236  
Cable: BLUE STAR  
A

Blue Star Ltd.  
7 Hare Street  
**CALCUTTA** 700 001  
Tel: 230131, 230132  
Telex: 021-7655  
Cable: BLUESTAR  
A,M

Blue Star Ltd.  
133 Kodambakkam High Road  
**MADRAS** 600 034  
Tel: 472056, 470238  
Telex: 041-379  
Cable: BLUESTAR  
A,M

Blue Star Ltd.  
13 Community Center  
New Friends Colony  
**NEW DELHI** 110 065  
Tel: 633773, 634473  
Telex: 031-61120  
Cable: BLUEFROST  
A,C\*,CM,E,M

Blue Star Ltd.  
15/16 C Wellesley Rd.  
**PUNE** 411 011  
Tel: 22775  
Cable: BLUE STAR  
A

Blue Star Ltd.  
2-2-47/1108 Bolarum Rd.  
**SECUNDERABAD** 500 003  
Tel: 72057, 72058  
Telex: 0155645  
Cable: BLUEFROST  
A,E

Blue Star Ltd.  
T.C. 7/603 Poornima  
Maruthunkuzhi  
**TRIVANDRUM** 695 013  
Tel: 65799, 65820  
Telex: 0884-259  
Cable: BLUESTAR  
E

Computer Maintenance Corporation  
Ltd.  
115, Sarojini Devi Road  
**SECUNDERABAD** 500 003  
Tel: 310-184, 345-774  
Telex: 031-2960  
C\*\*

## INDONESIA

BERCA Indonesia P.T.  
P.O.Box 496/Jkt.  
Jl. Abdul Muis 62  
**JAKARTA**  
Tel: 21-373009  
Telex: 46748 BERSAL IA  
Cable: BERSAL JAKARTA  
P

BERCA Indonesia P.T.  
P.O.Box 2497/Jkt  
Antara Bldg., 12th Floor  
Jl. Medan Merdeka Selatan 17  
**JAKARTA-PUSAT**  
Tel: 21-340417, 341445  
Telex: 46748 BERSAL IA  
A,C,E,M

BERCA Indonesia P.T.  
Jalan Kutai 24  
**SURABAYA**  
Tel: 67118  
Telex: 31146 BERSAL SB  
Cable: BERSAL-SURABAYA  
A\*,E,M,P

## IRAQ

Hewlett-Packard Trading S.A.  
Service Operation  
Al Mansoor City 9B/3/7  
**BAGHDAD**  
Tel: 551-49-73  
Telex: 212-455 HEPAIRAQ IK  
C

## IRELAND

Hewlett-Packard Ireland Ltd.  
82/83 Lower Leeson Street  
**DUBLIN** 2  
Tel: 0001 608800  
Telex: 30439  
A,C,CM,E,M,P

Cardiac Services Ltd.  
Kilmore Road  
Artane  
**DUBLIN** 5  
Tel: (01) 351820  
Telex: 30439  
M



# SALES & SUPPORT OFFICES

Arranged alphabetically by country

## ISRAEL

Eidan Electronic Instrument Ltd.  
P.O.Box 1270

**JERUSALEM** 91000

16, Ohaliav St.  
**JERUSALEM** 94467

Tel: 533 221, 553 242  
Telex: 25231 AB/PAKRD IL  
A,M

Computation and Measurement  
Systems (CMS) Ltd.  
11 Masad Street  
67060

## TEL-AVIV

Tel: 388 388  
Telex: 33569 Motil IL  
C,C,M,E,P

## ITALY

Hewlett-Packard Italiana S.p.A.  
Traversa 99C  
Via Giulio Petroni, 19  
I-70124 **BARI**  
Tel: (080) 41-07-44  
C,M

Hewlett-Packard Italiana S.p.A.  
Via Emilia, 51/C  
I-40011 **BOLOGNA** Anzola Dell'Emilia  
Tel: (051) 731061  
Telex: 511630  
C,E,M

Hewlett-Packard Italiana S.p.A.  
Via Principe Nicola 43G/C  
I-95126 **CATANIA**  
Tel: (095) 37-10-87  
Telex: 970291  
C

Hewlett-Packard Italiana S.p.A.  
Via G. Di Vittorio 9  
I-20063 **CERNUSCO SUL  
NAVIGLIO**  
(Milano)  
Tel: (02) 4459041  
Telex: 334632  
A,C,C,M,E,M,P

Hewlett-Packard Italiana S.p.A.  
Via C. Colombo 49  
I-20090 **TREZZANO SUL  
NAVIGLIO**  
(Milano)  
Tel: (02) 4459041  
Telex: 322116  
C

Hewlett-Packard Italiana S.p.A.  
Via Nuova San Rocco a  
Capodimonte, 62/A  
I-80131 **NAPOLI**  
Tel: (081) 7413544  
Telex: 710698  
A\*\*,C,E,M

Hewlett-Packard Italiana S.p.A.  
Viale G. Modugno 33  
I-16156 **GENOVA PEGLI**  
Tel: (010) 68-37-07  
Telex: 215238  
C,E

Hewlett-Packard Italiana S.p.A.  
Via Pelizzo 15  
I-35128 **PADOVA**  
Tel: (049) 664888  
Telex: 430315  
A,C,E,M

Hewlett-Packard Italiana S.p.A.  
Viale C. Pavese 340  
I-00144 **ROMA EUR**  
Tel: (06) 54831  
Telex: 610514  
A,C,E,M,P\*

Hewlett-Packard Italiana S.p.A.  
Via di Casellina 57/C  
I-50018 **SCANDICCI-FIRENZE**  
Tel: (055) 753863  
C,E,M

Hewlett-Packard Italiana S.p.A.  
Corso Svizzera, 185  
I-10144 **TORINO**  
Tel: (011) 74 4044  
Telex: 221079  
A\*,C,E

## IVORY COAST

S.I.T.E.L.  
Societe Ivoirienne de  
Telecommunications  
Bd. Giscard d'Estaing  
Carrefour Marcory  
Zone 4.A.  
Boite postale 2580  
**ABIDJAN** 01  
Tel: 353600  
Telex: 43175  
E

S.I.T.I.  
Immeuble "Le General"  
Av. du General de Gaulle  
01 BP 161  
**ABIDJAN** 01  
Tel: 321227  
C,P

## JAPAN

Yokogawa-Hewlett-Packard Ltd.  
152-1, Onna  
**ATSUGI**, Kanagawa, 243  
Tel: (0462) 25-0031  
C,C,M,E

Yokogawa-Hewlett-Packard Ltd.  
Meiji-Seimei Bldg. 6F  
3-1 Hon Chiba-Cho  
**CHIBA**, 280  
Tel: 472 25 7701  
C,E

Yokogawa-Hewlett-Packard Ltd.  
Yasuda-Seimei Hiroshima Bldg.  
6-11, Hon-dori, Naka-ku  
**HIROSHIMA**, 730  
Tel: 82-241-0611

Yokogawa-Hewlett-Packard Ltd.  
Towa Building  
2-3, Kaigan-dori, 2 Chome Chuo-ku  
**KOBE**, 650  
Tel: (078) 392-4791  
C,E

Yokogawa-Hewlett-Packard Ltd.  
Kumagaya Asahi 82 Bldg  
3-4 Tsukuba  
**KUMAGAYA**, Saitama 360  
Tel: (0485) 24-6563  
C,C,M,E

Yokogawa-Hewlett-Packard Ltd.  
Asahi Shinbun Daiichi Seimei Bldg.  
4-7, Hanabata-cho  
**KUMAMOTO**, 860  
Tel: (096) 354-7311  
C,E

Yokogawa-Hewlett-Packard Ltd.  
Shin-Kyoto Center Bldg.  
614, Higashi-Shiokoji-cho  
Karasuma-Nishiru  
Shiokoji-dori, Shimogyo-ku  
**KYOTO**, 600  
Tel: 075-343-0921  
C,E

Yokogawa-Hewlett-Packard Ltd.  
Mito Mitsui Bldg  
4-73, Sanno-maru, 1 Chome  
**MITO**, Ibaraki 310  
Tel: (0292) 25-7470  
C,C,M,E

Yokogawa-Hewlett-Packard Ltd.  
Meiji-Seimei Kokubun Bldg. 7-8  
Kokubun. 1 Chome, Sendai  
**MIYAGI**, 980  
Tel: (0222) 25-1011  
C,E

Yokogawa-Hewlett-Packard Ltd.  
Nagoya Kokusai Center Building  
47-1, Nagono, 1 Chome  
Nakamura-ku  
**NAGOYA**, 450  
Tel: (052) 571-5171  
C,C,M,E,M

Yokogawa-Hewlett-Packard Ltd.  
Saikyoren Building  
1-2 Dote-machi, **OHMIYA**  
Saitama 330  
Tel: (0486) 45-8031

Yokogawa-Hewlett-Packard Ltd.  
Chuo Bldg.  
4-20 Nishinakajima, 5 Chome  
Yodogawa-ku  
**OSAKA**, 532  
Tel: (06) 304-6021  
Telex: YHPOSA 523-3624  
A,C,C,M,E,M,P\*

Yokogawa-Hewlett-Packard Ltd.  
27-15, Yabe, 1 Chome  
**SAGAMIHARA** Kanagawa, 229  
Tel: 0427 59-1311

Yokogawa-Hewlett-Packard Ltd.  
Daiichi Seimei Bldg.  
7-1, Nishi Shinjuku, 2 Chome  
Shinjuku-ku, **TOKYO** 160  
Tel: 03-348-4611  
C,E

Yokogawa-Hewlett-Packard Ltd.  
29-21 Takaido-Higashi, 3 Chome  
Suginami-ku **TOKYO** 168  
Tel: (03) 331-6111  
Telex: 232-2024 YHPTOK  
A,C,C,M,E,M,P\*

Yokogawa Hokushin Electric Corp.  
9-32 Nokacho 2 Chome  
2 Chome Musashino-shi  
**TOKYO**, 180  
Tel: (0422) 54-1111  
Telex: 02822-421 YEW MTK J  
A

Yokogawa-Hewlett-Packard Ltd.  
Meiji-Seimei  
Utsunomiya Odori Building  
1-5 Odori, 2 Chome  
**UTSUNOMIYA**, Tochigi 320  
Tel: (0286) 33-1153  
C,E

Yokogawa-Hewlett-Packard Ltd.  
Yasuda Seimei Yokohama Nishiguchi  
Bldg.  
30-4 Tsuruya-cho, 3 Chome  
**YOKOHAMA** 221  
Tel: (045) 312-1252  
C,E

## JORDAN

Scientific and Medical Supplies Co.  
P.O. Box 1387  
**AMMAN**  
Tel: 24907, 39907  
Telex: 21456 SABCO JO  
C,E,M,P

## KENYA

ADCOM Ltd., Inc., Kenya  
P.O.Box 30070  
**NAIROBI**  
Tel: 331955  
Telex: 22639  
E,M

## KOREA

Samsung Hewlett-Packard Co. Ltd.  
Dongbang Yeoeuido Building  
12-16th Floors  
36-1 Yeoeuido-dong  
Yongdeungpo-ku  
**SEOUL**  
Tel: 784-2666, 784-4666  
Telex: 25166 SAMSAN K  
A,C,C,M,E,M,P

Young In Scientific Co., Ltd.  
Youngwha Building  
547 Shinsa Dong, Kangnam-ku  
**SEOUL** 135  
Tel: 5467771  
Telex: K23457 GINSCO  
A

## KUWAIT

Al-Khaldiya Trading & Contracting  
P.O. Box 830  
**SAFAT**  
Tel: 424910, 411726  
Telex: 22481 AREEG KT  
Cable: VISCOUNT  
E,M,A

Gulf Computing Systems  
P.O. Box 25125  
**SAFAT**  
Tel: 435969  
Telex: 23648  
P

Photo & Cine Equipment  
P.O. Box 270  
**SAFAT**  
Tel: 2445111  
Telex: 22247 MATIN KT  
Cable: MATIN KUWAIT  
P

W.J. Towell Computer Services  
P.O. Box 5897  
**SAFAT**  
Tel: 2462640  
Telex: 30336 TOWELL KT  
C

## LEBANON

Computer Information Systems S.A.L.  
Chammas Building  
P.O. Box 11-6274 Dora  
**BEIRUT**  
Tel: 89 40 73  
Telex: 42309  
C,E,M,P

## LIBERIA

Unichemicals Inc.  
P.O. Box 4509  
**MONROVIA**  
Tel: 224282  
Telex: 4509  
E

## MADAGASCAR

Technique et Precision  
12, rue de Nice  
P.O. Box 1227  
101 **ANTANANARIVO**  
Tel: 22090  
Telex: 22255  
P

## LUXEMBOURG

Hewlett-Packard Belgium S.A./N.V.  
Blvd de la Woluwe, 100  
Woluwedal  
B-1200 **BRUSSELS**  
Tel: (02) 762-32-00  
Telex: 23-494 paloben bru  
A,C,C,M,E,M,P

## MALAYSIA

Hewlett-Packard Sales (Malaysia)  
Sdn. Bhd.  
9th Floor  
Chung Khiaw Bank Building  
46, Jalan Raja Laut  
**KUALA LUMPUR**  
Tel: 03-986555  
Telex: 31011 HPSM MA  
A,C,E,M,P\*

Protel Engineering  
P.O.Box 1917  
Lot 6624, Section 64  
23/4 Pending Road  
Kuching, **SARAWAK**  
Tel: 36299  
Telex: 70904 PROMAL MA  
Cable: PROTELENG  
A,E,M

## MALTA

Philip Toledo Ltd.  
Birkirkara P.O. Box 11  
Notabile Rd.  
**MRIEHEL**  
Tel: 447 47, 455 66  
Telex: 1649  
E,M,P

## MAURITIUS

Blanche Birger Co. Ltd.  
18, Jules Koenig Street  
**PORT LOUIS**  
Tel: 20828  
Telex: 4296  
P

## MEXICO

Hewlett-Packard de Mexico, S.A.  
Francisco J. Allan #30  
Colonia Nueva  
Los Angeles 27140  
**COAHUILA**, Torreón  
Tel: 37220  
P

Hewlett-Packard de Mexico, S.A.  
Monti Morelos 299  
Fraccionamiento Loma Bonita 45060  
**GUADALAJARA**, Jalisco  
Tel: 316630/314600  
Telex: 0684 186 ECOMEX  
P

# SALES & SUPPORT OFFICES

Arranged alphabetically by country



## MEXICO (Cont'd)

Microcomputadoras Hewlett-Packard, S.A.

Monti Pelvoux 115  
**LOS LOMAS**, Mexico, D.F.  
Tel: 520-9127  
P

Hewlett-Packard Mexicana, S.A. de C.V.  
Av. Periferico Sur No. 6501  
Tepepan, Xochimilco  
16020 **MEXICO D.F.**  
Tel: 6-76-46-00  
Telex: 17-74-507 HEWPACK MEX  
A,C,CM,E,M,P

Hewlett-Packard De Mexico (Polanco)  
Avenida Ejercito Nacional #579  
2da y 3er piso  
Colonia Granada 11560  
**MEXICO D.F.**  
Tel: 254-4433  
P

Hewlett-Packard De Mexico, S.A. de C.V.  
Czda. del Valle  
409 Ote. 4th Piso  
Colonia del Valle  
Municipio de Garza García  
66220 **MONTERREY**, Nuevo León  
Tel: 78 42 41  
Telex: 038 410  
P

## MOROCCO

Etablissement Hubert Doibeau & Fils  
81 rue Karatchi  
B.P. 11133

**CASABLANCA**  
Tel: 3041-82, 3068-38  
Telex: 23051, 22822  
E

Gerep  
2, rue Agadir  
Boite Postale 156  
**CASABLANCA** 01  
Tel: 272093, 272095  
Telex: 23 739  
P

Sema-Maroc  
Dept. Seric  
6, rue Lapebie  
**CASABLANCA**  
Tel: 260980  
Telex: 21641  
C,P

## NETHERLANDS

Hewlett-Packard Nederland B.V.  
Startbaan 16  
1187 XR **AMSTELVEEN**  
P.O. Box 667  
NL 1180 AR **AMSTELVEEN**  
Tel: (020) 547-6911  
Telex: 13 216 HEPAC NL  
A,C,CM,E,M,P

Hewlett-Packard Nederland B.V.  
Bongerd 2  
NL 2906VK **CAPELLE A/D IJSEL**  
P.O. Box 41  
NL 2900AA **CAPELLE A/D IJSEL**  
Tel: (10) 51-64-44  
Telex: 21261 HEPAC NL  
C,E

Hewlett-Packard Nederland B.V.  
Pastoor Petersstraat 134-136  
NL 5612 LV **EINDHOVEN**  
P.O. Box 2342  
NL 5600 CH **EINDHOVEN**  
Tel: (040) 326911  
Telex: 51484 hepae nl  
A,C,E,M,P

## NEW ZEALAND

Hewlett-Packard (N.Z.) Ltd.  
5 Owens Road  
P.O. Box 26-189  
Epsom, **AUCKLAND**  
Tel: 687-159  
Cable: HEWPAK Auckland  
C,CM,E,P\*

Hewlett-Packard (N.Z.) Ltd.  
4-12 Cruickshank Street  
Kilbirnie, **WELLINGTON 3**  
P.O. Box 9443  
Courtenay Place, **WELLINGTON 3**  
Tel: 877-199  
Cable: HEWPACK Wellington  
C,CM,E,P

Northrop Instruments & Systems Ltd.  
369 Khyber Pass Road  
P.O. Box 8602

**AUCKLAND**  
Tel: 794-091  
Telex: 60605  
A,M

Northrop Instruments & Systems Ltd.  
110 Mandeville St.

P.O. Box 8388  
**CHRISTCHURCH**  
Tel: 488-873  
Telex: 4203  
A,M

Northrop Instruments & Systems Ltd.  
Sturdee House  
85-87 Ghuznee Street  
P.O. Box 2406  
**WELLINGTON**  
Tel: 850-091  
Telex: NZ 3380  
A,M

## NIGERIA

Elmecco Nigeria Ltd.  
46, Calcutta Crescent Apapa  
P.O. Box 244and  
**LAGOS**  
E

## NORTHERN IRELAND

See United Kingdom

## NORWAY

Hewlett-Packard Norge A/S  
Folke Bernadottes vei 50  
P.O. Box 3558  
N-5033 **FYLLINGSDALEN** (Bergen)  
Tel: 0047/5/16 55 40  
Telex: 76621 hpnas n  
C,E,M

Hewlett-Packard Norge A/S  
Osterdalen 16-18  
P.O. Box 34  
N-1345 **ØSTERÅS**  
Tel: 0047/2/17 11 80  
Telex: 76621 hpnas n  
A,C,CM,E,M,P

## OMAN

Khirmji Ramdas  
P.O. Box 19  
**MUSCAT/SULTANATE OF OMAN**  
Tel: 745601  
Telex: 5289 BROKER MB MUSCAT  
P

Suhail & Saud Bahwan  
P.O. Box 169  
**MUSCAT/SULTANATE OF OMAN**  
Tel: 734201  
Telex: 5274 BAHWAN MB  
E

Imtac LLC  
P.O. Box 8676  
**MUTRAH/SULTANATE OF OMAN**  
Tel: 601695  
Telex: 5741 Tawoos On  
A,C,M

## PAKISTAN

Mushko & Company Ltd.  
House No. 16, Street No. 16  
Sector F-6/3

**ISLAMABAD**  
Tel: 824545  
Cable: FEMUS Islamabad  
A,E,M,P\*

Mushko & Company Ltd.  
Oosman Chambers  
Abdullah Haroon Road  
**KARACHI** 0302  
Tel: 524131, 524132  
Telex: 2894 MUSKO PK  
Cable: COOPERATOR Karachi  
A,E,M,P\*

## PANAMA

Electronico Balboa, S.A.  
Calle Samuel Lewis, Ed. Alfa  
Apartado 4929  
**PANAMA 5**  
Tel: 64-2700  
Telex: 3483 ELECTRON PG  
A,C,M,E,M,P

## PERU

Cía Electro Médica S.A.  
Los Flamencos 145, Otc. 301/2  
San Isidro  
Casilla 1030  
**LIMA 1**  
Tel: 41-4325, 41-3705  
Telex: Pub. Booth 25306 PEC PISIDR  
CM,E,M,P

SAMS  
Arenida Republica de Panama 3534  
San Isidro, LIMA  
Tel: 419928/417108  
Telex: 20450 PE LIBERTAD  
A,C,P

## PHILIPPINES

The Online Advanced Systems Corp.  
2nd Floor, Electra House  
115-117 Esteban Street  
Legaspi Village, Makati  
P.O. Box 1510  
Metro **MANILA**  
Tel: 815-38-10 (up to 16)  
Telex: 63274 ONLINE PN  
A,C,E,M,P

## PORTUGAL

Mundinter Intercambio  
Mundial de Comércio S.A.R.L.  
Av. Antonio Augusto Aguiar 138  
Apartado 2761  
**LISBON**  
Tel: (19) 53-21-31, 53-21-37  
Telex: 16691 munter p  
M

Soquimica  
Av. da Liberdade, 220-2  
1298 **LISBOA** Codex  
Tel: 56-21-82  
Telex: 13316 SABASA  
A

Telectra-Empresa Técnica de Equipamentos Eléctricos S.A.R.L.  
Rua Rodrigo da Fonseca 103  
P.O. Box 2531  
**LISBON 1**  
Tel: (19) 68-60-72  
Telex: 12598  
CM,E

C.P.C.S.I.  
Rua de Costa Cabral 575  
4200 **PORTO**  
Tel: 499174/495173  
Telex: 26054  
C,P

## PUERTO RICO

Hewlett-Packard Puerto Rico  
101 Muñoz Rivera Av  
Esu. Calle Ochoa  
**HATO REY**, Puerto Rico 00918  
Tel: (809) 754-7800  
A,C,CM,M,E,P

## QATAR

Computer Arabia  
P.O. Box 2750  
**DOHA**  
Tel: 428555  
Telex: 4806 CHPARB  
P

Nasser Trading & Contracting  
P.O. Box 1563  
**DOHA**  
Tel: 422170  
Telex: 4439 NASSER DH  
M

## SAUDI ARABIA

Modern Electronics Establishment  
Hewlett-Packard Division  
P.O. Box 281  
Thouqbah  
**AL-KHOBAR** 31952  
Tel: 895-1760, 895-1764  
Telex: 671 106 HPMEEK SJ  
Cable: ELECTA AL-KHOBAR  
C,E,M

Modern Electronics Establishment  
Hewlett-Packard Division  
P.O. Box 1228  
**JEDDAH**  
Tel: 644 96 28  
Telex: 4027 12 FARNAS SJ  
Cable: ELECTA JEDDAH  
A,C,CM,E,M,P

Modern Electronics Establishment  
Hewlett-Packard Division  
P.O. Box 22015  
**RIYADH** 11495  
Tel: 476-3030  
Telex: 202049 MEERYD SJ  
A,C,CM,E,M,P

Abdul Ghani El Ajou Corp.  
P.O. Box 78  
**RIYADH**  
Tel: 40 41 717  
Telex: 200 931 EL AJOU  
P

## SCOTLAND

See United Kingdom

## SENEGAL

Societe Hussein Ayad & Cie.  
76, Avenue Georges Pompidou  
B.P. 305  
**DAKAR**  
Tel: 32339  
Cable: AYAD-Dakar  
E

Moneger Distribution S.A.  
1, Rue Parent  
B.P. 148  
**DAKAR**  
Tel: 215 671  
Telex: 587  
P

Systeme Service Conseil (SSC)  
14, Avenue du Parachois  
**DAKAR ETOILE**  
Tel: 219976  
Telex: 577  
C,P

## SINGAPORE

Hewlett-Packard Singapore (Sales)  
Pte. Ltd.  
08-00 Inchcape House  
450-2 Alexandra Road  
Alexandra P.O. Box 58  
**SINGAPORE**, 9115  
Tel: 4731788  
Telex: 34209 HPSGSO RS  
Cable: HEWPACK, Singapore  
A,C,E,M,P

Dynamar International Ltd.  
Unit 05-11 Block 6  
Kolam Ayer Industrial Estate  
**SINGAPORE** 1334  
Tel: 747-6188  
Telex: 26283 RS  
CM

## SOUTH AFRICA

Hewlett-Packard So Africa (Pty.) Ltd.  
P.O. Box 120  
Howard Place **CAPE PROVINCE** 7450  
Pine Park Center, Forest Drive, Pine-lands  
**CAPE PROVINCE** 7405  
Tel: (021) 53 7954  
Telex: 57-20006  
A,C,CM,E,M,P

Hewlett-Packard So Africa (Pty.) Ltd.  
2nd Floor Juniper House  
92 Overport Drive  
**DURBAN** 4067  
Tel: (031) 28-4178  
Telex: 6-22954  
C

Hewlett-Packard So Africa (Pty.) Ltd.  
6 Linton Arcade  
511 Cape Road  
Linton Grange  
**PORT ELIZABETH** 6001  
Tel: 041-301201  
Telex: 24-2916  
C



# SALES & SUPPORT OFFICES

Arranged alphabetically by country

## SOUTH AFRICA (Cont'd)

Hewlett-Packard So Africa (Pty.) Ltd.  
Fountain Center  
Kaikden Str.  
Monument Park Ext 2  
**PRETORIA** 0105  
Tel: (012) 45 57258  
Telex: 3-21063  
C,E

Hewlett-Packard So Africa (Pty.) Ltd.  
Private Bag Wendywood  
**SANDTON** 2144  
Tel: 802-5111, 802-5125  
Telex: 4-20877 SA  
Cable: HEWPACK Johannesburg  
A,C,M,E,M,P

## SPAIN

Hewlett-Packard Española S.A.  
Calle Entenza, 321  
**08029 BARCELONA**  
Tel: 3/322 24 51, 321 73 54  
Telex: 52603 hpbee  
A,C,E,M,P

Hewlett-Packard Española S.A.  
Calle San Vicente S/N  
Edificio Albia II-7B  
**48001 BILBAO**  
Tel: 4/423 83 06  
A,C,E,M

Hewlett-Packard Española S.A.  
Ctra. de la Coruña, Km. 16, 400  
Las Rozas  
**E-MADRID**  
Tel: (1) 637.00.11  
Telex: 23515 HPE  
C,M

Hewlett-Packard Española S.A.  
Avda. S. Francisco Javier, S/N  
Planta 10. Edificio Sevilla 2  
**41005 SEVILLA**  
Tel: 54/64 44 54  
Telex: 72933  
A,C,M,P

Hewlett-Packard Española S.A.  
Isabel La Católica, 8  
**46004 VALENCIA**  
Tel: 0034/6/351 59 44  
C,P

## SWEDEN

Hewlett-Packard Sverige AB  
Ostra Tullgatan 3  
S-21128 **MALMÖ**  
Tel: (040) 70270  
Telex: (854) 17886 (via Spånga  
office)  
C,P

Hewlett-Packard Sverige AB  
Skalhögsgatan 9, Kista  
Box 19  
S-16393 **SPÅNGA**  
Tel: (08) 750-2000  
Telex: (854) 17886  
Telefax: (08) 7527781  
A,C,M,E,M,P

Hewlett-Packard Sverige AB  
Fröfallsgratan 30  
S-42132 **VÄSTRA-FRÖLUNDA** (Gothen-  
burg)  
Tel: (031) 49-09-50  
Telex: (854) 17886 (via Spånga  
office)  
A,C,M,E,M,P

## SUDAN

Mediterranean Engineering & Trading  
Co. Ltd.  
P.O. Box 1025  
**KHARTOUM**  
Tel: 41184  
Telex: 24052  
C,P

## SWITZERLAND

Hewlett-Packard (Schweiz) AG  
Clarastrasse 12  
CH-4058 **BASEL**  
Tel: (61) 33-59-20  
A

Hewlett-Packard (Schweiz) AG  
7, rue du Bois-du-Lan  
Case postale 365  
CH-1217 **MEYRIN** 1  
Tel: (0041) 22-83-11-11  
Telex: 27333 HPAG CH  
C,CM

Hewlett-Packard (Schweiz) AG  
Allmend 2  
CH-8967 **WIDEN**  
Tel: (0041) 57 31 21 11  
Telex: 53933 hpag ch  
Cable: HPAG CH  
A,C,C,M,E,M,P

## SYRIA

General Electronic Inc.  
Nuri Basha Ahnaf Ebn Kays Street  
P.O. Box 5781  
**DAMASCUS**  
Tel: 33-24-87  
Telex: 411 215  
Cable: ELECTROBOR DAMASCUS  
E

Middle East Electronics  
P.O.Box 2308  
Abu Rumaneh  
**DAMASCUS**  
Tel: 33 45 92  
Telex: 411 771  
M

## TAIWAN

Hewlett-Packard Taiwan  
Kaohsiung Office  
11/F, 456, Chung Hsiao 1st Road  
**KAOHSIUNG**  
Tel: (07) 2412318  
C,E

Hewlett-Packard Taiwan  
8th Floor, Hewlett-Packard Building  
337 Fu Hsing North Road  
**TAIPEI**  
Tel: (02) 712-0404  
Telex: 24439 HEWPACK  
Cable: HEWPACK Taipei  
A,C,M,E,M,P  
Ing Lih Trading Co.  
3rd Floor, 7 Jen-Ai Road, Sec. 2  
**TAIPEI 100**  
Tel: (02) 3948191  
Cable: INGLIH Taipei  
A

## THAILAND

Unimesa Co. Ltd.  
30 Patpong Ave., Suriwong  
**BANGKOK** 5  
Tel: 235-5727  
Telex: 84439 Simonco TH  
Cable: UNIMESA Bangkok  
A,C,E,M

Bangkok Business Equipment Ltd.  
5/5-6 Dejo Road  
**BANGKOK**  
Tel: 234-8670, 234-8671  
Telex: 87699-BEQUIPT TH  
Cable: BUSIQUIPT Bangkok  
P

## TOGO

Societe Africaine De Promotion  
Immeuble Sagap  
22, Rue d'Atakparne  
B.P. 4150  
**LOME**  
Tel: 21-62-88  
Telex: 5304  
P

## TRINIDAD & TOBAGO

Caribbean Telecoms Ltd.  
Corner McAllister Street &  
Eastern Main Road, Laventille  
P.O. Box 732

## PORT-OF-SPAIN

Telex: 624-4213  
Telex: 22561 CARTEL WG  
Cable: CARTEL, PORT OF SPAIN  
C,M,E,M,P

Computer and Controls Ltd.  
P.O. Box 51  
66 Independence Square  
**PORT-OF-SPAIN**  
Tel: 62-279-85  
Telex: 3000 POSTLX WG, ACCT  
LOO90 AGENCY 1264  
A,P

Feral Assoc.  
8 Fitzgerald Lane  
**PORT-OF-SPAIN**  
Tel: 62-36864, 62-39255  
Telex: 22432 FERALCO  
Cable: FERALCO  
M

## TUNISIA

Precision Electronique S.A.R.L.  
31 Avenue de la Liberte  
**TUNIS**  
Tel: 893937  
Telex: 13238  
P

Tunisie Electronique S.A.R.L.  
94, Av. Jugurtha, Mutuelleville  
1002 **TUNIS-BELVEDERE**  
Tel: 280144  
Telex: 13238  
C,E,P

Corema S.A.  
23, bis Rue de Marseille  
**TUNIS**  
Tel: 253-821  
Telex: 14812 CABAM TN  
M

## TURKEY

E.M.A  
Mediha Eldem Sokak No. 41/6  
Yenisehir  
**ANKARA**  
Tel: 319175  
Telex: 46912 KTX TR  
Cable: EMATRADE ANKARA  
M

Teknim Company Ltd.  
Iran Caddesi No. 7  
Kavaklidere  
**ANKARA**  
Tel: 275800  
Telex: 42155 TKNM TR  
E,CM

Saniva Bilgisayar Sistemleri A.S.  
Buyukdere Caddesi 103/6  
Gayrettepe  
**ISTANBUL**  
Tel: 1727030  
Telex: 26345 SANI TR  
C,P

Best Inc.  
Esentepe, Gazeteciler Sitesi  
Keskin Kaleny  
Sokak 6/3, Gayrettepe  
**ISTANBUL**  
Tel: 1721328  
Telex: 42490  
A

## UNITED ARAB EMIRATES

Emitac Ltd.  
P.O. Box 1641  
**SHARJAH**  
Tel: 591181  
Telex: 68136 EMITAC EM  
Cable: EMITAC SHARJAH  
E,C,M,P,A

Emitac Ltd.  
P.O. Box 2711  
**ABU DHABI**  
Tel: 820419-20  
Cable: EMITACH ABUDHABI

Emitac Ltd.  
P.O. Box 8391  
**DUBAI**  
Tel: 377591  
Emitac Ltd.  
P.O. Box 473  
**RAS AL KHAIMAH**  
Tel: 28133, 21270

## UNITED KINGDOM

### GREAT BRITAIN

Hewlett-Packard Ltd.  
Trafalgar House  
Navigation Road  
**ALTRINCHAM**  
Cheshire WA14 1NU  
Tel: 061 928 6422  
Telex: 668068  
A,C,E,M,P

Hewlett-Packard Ltd.  
Miller House  
The Ring, **BRACKNELL**  
Berks RG12 1XN  
Tel: 0344 424898  
Telex: 848733  
E

Hewlett-Packard Ltd.  
Elstree House, Elstree Way  
**BOREHAMWOOD**, Herts WD6 1SG  
Tel: 01 207 5000  
Telex: 8952716  
C,E

Hewlett-Packard Ltd.  
Oakfield House, Oakfield Grove  
Clifton **BRISTOL**, Avon BS8 2BN  
Tel: 0272 736806  
Telex: 444302  
C,E,P

Hewlett-Packard Ltd.  
Bridewell House  
9 Bridewell Place  
**LONDON EC4V 6BS**  
Tel: 01 583 6565  
Telex: 298163  
C,P

Hewlett-Packard Ltd.  
Pontefract Road  
**NORMANTON**, West Yorkshire WF6 1RN  
Tel: 0924 895566  
Telex: 557355  
C,P

Hewlett-Packard Ltd.  
The Quadrangle  
106-118 Station Road  
**REDHILL**, Surrey RH1 1PS  
Tel: 0737 68655  
Telex: 947234  
C,E,P

Hewlett-Packard Ltd.  
Avon House  
435 Stratford Road  
Shirley, **SOLIHULL**, West Midlands  
B90 4BL  
Tel: 021 745 8800  
Telex: 339105  
C,E,P

Hewlett-Packard Ltd.  
West End House  
41 High Street, West End  
**SOUTHAMPTON**  
Hampshire SO3 3DQ  
Tel: 0703 476767  
Telex: 477138  
C,P

Hewlett-Packard Ltd.  
Harmon House  
No. 1 George Street  
**UXBRIDGE**, Middlesex UX8 1YH  
Tel: 895 720 20  
Telex: 893134/5  
C,C,M,E,M,P

Hewlett-Packard Ltd.  
King Street Lane  
Winnersh, **WOKINGHAM**  
Berkshire RG11 5AR  
Tel: 0734 784774  
Telex: 847178  
A,C,E,M,P

## IRELAND

### NORTHERN IRELAND

Hewlett-Packard (Ireland) Ltd.  
Carrickfergus Industrial Centre  
75 Belfast Road, Carrickfergus  
**BELFAST BT38 8PH**  
Tel: 09603 67333  
Telex: 747626  
C,E

## SCOTLAND

Hewlett-Packard Ltd.  
8 Woodside Place  
**GLASGOW**, G3 7QF  
Tel: 041 332 6232  
Telex: 779615  
C,E

Hewlett-Packard Ltd.  
**SOUTH QUEENSFERRY**  
West Lothian, EH30 9TG  
Tel: 031 331 1188  
Telex: 72682  
C,C,M,E,M,P



# SALES & SUPPORT OFFICES

Arranged alphabetically by country

7



## UNITED STATES

### Alabama

Hewlett-Packard Co.  
700 Century Park South, Suite 128  
**BIRMINGHAM, AL** 35226  
Tel: (205) 822-6802  
A,C,M,P\*

Hewlett-Packard Co.  
420 Wynn Drive  
**HUNTSVILLE, AL** 35805  
Tel: (205) 830-2000  
C,CM,E,M\*

### Alaska

Hewlett-Packard Co.  
3601 C St., Suite 1416  
**ANCHORAGE, AK** 99503  
Tel: (907) 563-8855  
C,E

### Arizona

Hewlett-Packard Co.  
8080 Pointe Parkway West  
**PHOENIX, AZ** 85044  
Tel: (602) 273-8000  
A,C,CM,E,M,P

Hewlett-Packard Co.  
3400 East Britannia Dr.  
Bldg. C, Suite 124  
**TUCSON, AZ** 85706  
Tel: (602) 573-7400  
C,E,M\*\*

### California

Hewlett-Packard Co.  
99 South Hill Dr.  
**BRISBANE, CA** 94005  
Tel: (415) 330-2500  
C

Hewlett-Packard Co.  
5060 E. Clinton Avenue, Suite 102  
**FRESNO, CA** 93727  
Tel: (209) 252-9652  
C,M

Hewlett-Packard Co.  
1421 S. Manhattan Av.  
**FULLERTON, CA** 92631  
Tel: (714) 999-6700  
C,CM,E,M

Hewlett-Packard Co.  
7408 Hollister Ave. #A  
**GOLETA, CA** 93117  
Tel: (805) 685-6100  
C,E

Hewlett-Packard Co.  
5400 W. Rosecrans Blvd.  
**LAWDALE, CA** 90260  
Tel: (213) 643-7500  
Telex: 910-325-6608  
C,M

Hewlett-Packard Co.  
2525 Grand Avenue  
Long Beach, CA 90815  
Tel: (213) 498-1111  
C

Hewlett-Packard Co.  
3155 Porter Drive  
**PALO ALTO, CA** 94304  
Tel: (415) 857-8000  
C,E

Hewlett-Packard Co.  
4244 So. Market Court, Suite A  
**SACRAMENTO, CA** 95834  
Tel: (916) 929-7222  
A\*,C,E,M

Hewlett-Packard Co.  
9606 Aero Drive  
**SAN DIEGO, CA** 92123  
Tel: (619) 279-3200  
C,CM,E,M

Hewlett-Packard Co.  
5725 W. Las Positas Blvd.  
Pleasanton, CA 94566  
Tel: (415) 460-0282  
C

Hewlett-Packard Co.  
3003 Scott Boulevard  
**SANTA CLARA, CA** 95054  
Tel: (408) 988-7000  
Telex: 910-338-0586  
A,C,CM,E

Hewlett-Packard Co.  
2150 W. Hillcrest Dr.  
**THOUSAND OAKS, CA** 91320  
(805) 373-7000  
C,CM,E

### Colorado

Hewlett-Packard Co.  
2945 Center Green Court South  
Suite A  
**BOULDER, CO** 80301  
Tel: (303) 938-3005  
A,C,E

Hewlett-Packard Co.  
24 Inverness Place, East  
**ENGLEWOOD, CO** 80112  
Tel: (303) 649-5000  
A,C,CM,E,M

### Connecticut

Hewlett-Packard Co.  
500 Sylvan Av.  
**BRIDGEPORT, CT** 06606  
Tel: (203) 371-6454  
C,E

Hewlett-Packard Co.  
47 Barnes Industrial Road South  
**WALLINGFORD, CT** 06492  
Tel: (203) 265-7801  
A,C,CM,E,M

### Florida

Hewlett-Packard Co.  
2901 N.W. 62nd Street  
**FORT LAUDERDALE, FL** 33309  
Tel: (305) 973-2600  
C,E,M,P\*

Hewlett-Packard Co.  
6800 South Point Parkway  
Suite 301  
**JACKSONVILLE, FL** 32216  
Tel: (904) 398-0663  
C\*,M\*\*

Hewlett-Packard Co.  
6177 Lake Ellenor Drive  
**ORLANDO, FL** 32809  
Tel: (305) 859-2900  
A,C,CM,E,P\*

Hewlett-Packard Co.  
4700 Bayou Blvd.  
Building 5  
**PENSACOLA, FL** 32503  
Tel: (904) 476-8422  
A,C,M

Hewlett-Packard Co.  
5550 W. Idelwild, 150  
**TAMPA, FL** 33614  
Tel: (813) 884-3282  
C,E,M,P

### Georgia

Hewlett-Packard Co.  
2000 South Park Place  
**ATLANTA, GA** 30339  
Tel: (404) 955-1500  
Telex: 810-766-4890  
A,C,CM,E,M,P\*

Hewlett-Packard Co.  
3607 Parkway Lane  
Suite 300  
**NORCROSS, GA** 30092  
Tel: (404) 448-1894  
C,E,P

### Hawaii

Hewlett-Packard Co.  
Kawaiahao Plaza, Suite 190  
567 South King Street  
**HONOLULU, HI** 96813  
Tel: (808) 526-1555  
A,C,E,M

### Idaho

Hewlett-Packard Co.  
11309 Chinden Blvd.  
**BOISE, ID** 83707  
Tel: (208) 323-2700  
C

### Illinois

Hewlett-Packard Co.  
304 Eldorado Road  
P.O. Box 1607  
**BLOOMINGTON, IL** 61701  
Tel: (309) 662-9411  
C,M\*\*

Hewlett-Packard Co.  
525 W. Monroe, 1308  
**CHICAGO, IL** 60606  
Tel: (312) 930-0010  
C

Hewlett-Packard Co.  
1200 East Diehl Road  
**NAPERVILLE, IL** 60566  
Tel: (312) 357-8800  
C

Hewlett-Packard Co.  
5201 Tolview Drive  
**ROLLING MEADOWS, IL** 60008  
Tel: (312) 255-9800  
Telex: 910-687-1066  
A,C,CM,E,M

### Indiana

Hewlett-Packard Co.  
11911 N. Meridian St.  
**CARMEL, IN** 46032  
Tel: (317) 844-4100  
A,C,CM,E,M

Hewlett-Packard Co.  
3702 Rupp Drive  
**FT. WAYNE, IN** 46815  
Tel: (219) 482-4283  
C,E

### Iowa

Hewlett-Packard Co.  
4070 22nd Av. SW  
**CEDAR RAPIDS, IA** 52404  
Tel: (319) 390-4250  
C,E,M

Hewlett-Packard Co.  
4201 Corporate Dr.  
**WEST DES MOINES, IA** 50265  
Tel: (515) 224-1435  
A\*\*,C,M\*\*

### Kansas

Hewlett-Packard Co.  
7804 East Funston Road, 203  
**WICHITA, KS** 67207  
Tel: (316) 684-8491  
C,E

### Kentucky

Hewlett-Packard Co.  
10300 Linn Station Road, 100  
**LOUISVILLE, KY** 40223  
Tel: (502) 426-0100  
A,C,M

### Louisiana

Hewlett-Packard Co.  
160 James Drive East  
**ST. ROSE, LA** 70087  
P.O. Box 1449  
**KENNER, LA** 70063  
Tel: (504) 467-4100  
A,C,E,M,P

### Maryland

Hewlett-Packard Co.  
3701 Koppers Street  
**BALTIMORE, MD** 21227  
Tel: (301) 644-5800  
Telex: 710-862-1943  
A,C,CM,E,M

Hewlett-Packard Co.  
2 Choke Cherry Road  
**ROCKVILLE, MD** 20850  
Tel: (301) 948-6370  
A,C,CM,E,M

### Massachusetts

Hewlett-Packard Co.  
1775 Minuteman Road  
**ANDOVER, MA** 01810  
Tel: (617) 682-1500  
A,C,CM,E,M,P\*

Hewlett-Packard Co.  
32 Hartwell Avenue  
**LEXINGTON, MA** 02173  
Tel: (617) 861-8960  
C,E

### Michigan

Hewlett-Packard Co.  
4326 Cascade Road S.E.  
**GRAND RAPIDS, MI** 49506  
Tel: (616) 957-1970  
C,M

Hewlett-Packard Co.  
39550 Orchard Hill Place Drive  
**NOVI, MI** 48020  
Tel: (313) 349-9200  
A,C,E,M

Hewlett-Packard Co.  
1771 W. Big Beaver Road  
**TROY, MI** 48064  
Tel: (313) 643-6474  
C

### Minnesota

Hewlett-Packard Co.  
2025 W. Larpentour Ave.  
**ST. PAUL, MN** 55113  
Tel: (612) 644-1100  
A,C,CM,E,M

### Missouri

Hewlett-Packard Co.  
1001 E. 101st Terrace Suite 120  
**KANSAS CITY, MO** 64131-3368  
Tel: (816) 941-0411  
A,C,CM,E,M

Hewlett-Packard Co.  
13001 Hollenberg Drive  
**BRIDGETON, MO** 63044  
Tel: (314) 344-5100  
A,C,E,M

### Nebraska

Hewlett-Packard Co.  
10824 Old Mill Rd., Suite 3  
**OMAHA, NE** 68154  
Tel: (402) 334-1813  
C,E,M

### New Jersey

Hewlett-Packard Co.  
120 W. Century Road  
**PARAMUS, NJ** 07653  
Tel: (201) 265-5000  
A,C,CM,E,M

Hewlett-Packard Co.  
20 New England Av. West  
**PISCATAWAY, NJ** 08854  
Tel: (201) 562-6100  
A,C,CM,E

### New Mexico

Hewlett-Packard Co.  
7801 Jefferson N.E.  
**ALBUQUERQUE, NM** 87109  
Tel: (505) 292-1330  
C,E,M

### New York

Hewlett-Packard Co.  
5 Computer Drive South  
**ALBANY, NY** 12205  
Tel: (518) 458-1550  
A,C,E,M

Hewlett-Packard Co.  
9600 Main Street  
**CLARENCE, NY** 14031  
Tel: (716) 759-8621  
C,E

Hewlett-Packard Co.  
200 Cross Keys Office Park  
**FAIRPORT, NY** 14450  
Tel: (716) 223-9950  
A,C,CM,E,M

Hewlett-Packard Co.  
7641 Henry Clay Blvd.  
**LIVERPOOL, NY** 13088  
Tel: (315) 451-1820  
A,C,CM,E,M

Hewlett-Packard Co.  
No. 1 Pennsylvania Plaza  
55th Floor  
34th Street & 8th Avenue  
**MANHATTAN NY** 10119  
Tel: (212) 971-0800  
C,M\*

Hewlett-Packard Co.  
15 Myers Corner Rd.  
Hollowbrook Park, Suite 20  
**WAPPINGER FALLS, NY** 12590  
CM,E

Hewlett-Packard Co.  
250 Westchester Avenue  
**WHITE PLAINS, NY** 10604  
Tel: (914) 684-6100  
C,CM,E

Hewlett-Packard Co.  
3 Crossways Park West  
**WOODBURY, NY** 11797  
Tel: (516) 682-7800  
A,C,CM,E,M



# SALES & SUPPORT OFFICES

Arranged alphabetically by country

## UNITED STATES Cont'd

### North Carolina

Hewlett-Packard Co.  
305 Gregson Dr.  
**CARY, NC 27511**  
Tel: (919) 467-6600  
C,CM,E,M,P\*

Hewlett-Packard Co.  
9600-H Southern Pine Blvd.  
**CHARLOTTE, NC 28210**  
Tel: (704) 527-8780  
C\*

Hewlett-Packard Co.  
5605 Roanne Way  
**GREENSBORO, NC 27420**  
Tel: (919) 852-1800  
A,C,CM,E,M,P\*

### Ohio

Hewlett-Packard Co.  
2717 S. Arlington Road  
**AKRON, OH 44312**  
Tel: (216) 644-2270  
C,E

Hewlett-Packard Co.  
23200 Chagrin Blvd #100  
**BEACHWOOD, OH 44122**  
Tel: (216) 292-4677  
C,P

Hewlett-Packard Co.  
9920 Carver Road  
**CINCINNATI, OH 45242**  
Tel: (513) 891-9870  
C,M

Hewlett-Packard Co.  
16500 Sprague Road  
**CLEVELAND, OH 44130**  
Tel: (216) 243-7300  
A,C,CM,E,M

Hewlett-Packard Co.  
9080 Springboro Pike  
**MIAMISBURG, OH 45342**  
Tel: (513) 433-2223  
A,C,CM,E\*,M

Hewlett-Packard Co.  
One Maritime Plaza, 5th Floor  
720 Water Street  
**TOLEDO, OH 43604**  
Tel: (419) 242-2200  
C

Hewlett-Packard Co.  
675 Brookside Blvd.  
**WESTERVILLE, OH 43081**  
Tel: (614) 891-3344  
C,CM,E\*

### Oklahoma

Hewlett-Packard Co.  
3525 N.W. 56th St.  
Suite C-100  
**OKLAHOMA CITY, OK 73112**  
Tel: (405) 946-9499  
C,E\*,M

Hewlett-Packard Co.  
3840 S. 103rd E. Ave., 100  
**TULSA, OK 74146**  
Tel: (918) 665-3300  
A\*,C,E,M\*,P\*

### Oregon

Hewlett-Packard Co.  
9255 S. W. Pioneer Court  
**WILSONVILLE, OR 97070**  
Tel: (503) 682-8000  
A,C,E\*,M

### Pennsylvania

Hewlett-Packard Co.  
50 Dorchester Rd.  
**HARRISBURG, PA 17112**  
Tel: (717) 657-5900  
C

Hewlett-Packard Co.  
111 Zeta Drive  
**PITTSBURGH, PA 15238**  
Tel: (412) 782-0400  
A,C,E,M

Hewlett-Packard Co.  
2750 Monroe Boulevard  
**VALLEY FORGE, PA 19482**  
Tel: (215) 666-9000  
A,C,CM,E,M

### South Carolina

Hewlett-Packard Co.  
Brookside Park, Suite 122  
1 Harbison Way  
**COLUMBIA, SC 29210**  
Tel: (803) 732-0400  
C,M

Hewlett-Packard Co.  
555 N. Pleasantburg Dr.  
Suite 107  
**GREENVILLE, SC 29607**  
Tel: (803) 232-8002  
C

### Tennessee

Hewlett-Packard Co.  
One Energy Centr. 200  
Pellissippi Pkwy.  
**KNOXVILLE, TN 37932**  
Tel: (615) 966-4747  
A,C,M

Hewlett-Packard Co.  
3070 Directors Row  
Directors Square  
**MEMPHIS, TN 38131**  
Tel: (901) 346-8370  
A,C,M

Hewlett-Packard Co.  
220 Great Circle Road, Suite 116  
**NASHVILLE, TN 37228**  
Tel: (615) 255-1271  
C,M,P\*

### Texas

Hewlett-Packard Co.  
1826-P Kramer Lane  
**AUSTIN, TX 78758**  
Tel: (512) 835-6771  
C,E,P\*

Hewlett-Packard Co.  
5700 Cromo Dr  
**EL PASO, TX 79912**  
Tel: (915) 833-4400  
C,E\*,M\*\*

Hewlett-Packard Co.  
3952 Sandshell Drive  
**FORT WORTH, TX 76137**  
Tel: (817) 232-9500  
C

Hewlett-Packard Co.  
10535 Harwin Drive  
**HOUSTON, TX 77036**  
Tel: (713) 776-6400  
A,C,E,M,P\*

Hewlett-Packard Co.  
511 E. John W. Carpenter Fwy.  
Royal Tech. Center 100  
**IRVING, TX 75062**  
Tel: (214) 556-1950  
C,E

Hewlett-Packard Co.  
109 E. Toronto, Suite 100  
**MCALLEN, TX 78503**  
Tel: (512) 630-3030  
C

Hewlett-Packard Co.  
930 E. Campbell Rd.  
**RICHARDSON, TX 75081**  
Tel: (214) 231-6101  
A,C,CM,E,M,P\*

Hewlett-Packard Co.  
1020 Central Parkway South  
**SAN ANTONIO, TX 78216**  
Tel: (512) 494-9336  
A,C,E,M,P\*

### Utah

Hewlett-Packard Co.  
3530 W. 2100 South  
**SALT LAKE CITY, UT 84119**  
Tel: (801) 974-1700  
A,C,E,M

### Virginia

Hewlett-Packard Co.  
4305 Cox Road  
**GLEN ALLEN, VA 23060**  
Tel: (804) 747-7750  
A,C,E,M,P\*

Hewlett-Packard Co.  
Tanglewood West Bldg.  
Suite 240  
3959 Electric Road  
**ROANOKE, VA 24018**  
Tel: (703) 774-3444  
C,E,P

### Washington

Hewlett-Packard Co.  
15815 S.E. 37th Street  
**BELLEVUE, WA 98006**  
Tel: (206) 643-4000  
A,C,CM,E,M

Hewlett-Packard Co.  
708 North Argonne Road  
**SPOKANE, WA 99212-2793**  
Tel: (509) 922-7000  
C

### West Virginia

Hewlett-Packard Co.  
501 56th  
**CHARLESTON, WV 25304**  
Tel: (304) 925-0492  
A,C,M

### Wisconsin

Hewlett-Packard Co.  
275 N. Corporate Dr.  
**BROOKFIELD, WI 53005**  
Tel: (414) 784-8800  
A,C,E\*,M

### URUGUAY

Pablo Ferrando S.A.C. e I.  
Avenida Italia 2877  
Casilla de Correo 370  
**MONTEVIDEO**  
Tel: 80-2586  
Telex: 802586  
A,CM,E,M

Olympia de Uruguay S.A.  
Maquinas de Oficina  
Avda. del Libertador 1997  
Casilla de Correos 6644  
**MONTEVIDEO**  
Tel: 91-1809, 98-3807  
Telex: 6342 OROU UY  
P

### VENEZUELA

Hewlett-Packard de Venezuela C.A.  
3A Transversal Los Ruices Norte  
Edificio Segre 2 & 3  
Apartado 50933  
**CARACAS 1071**  
Tel: 239-4133  
Telex: 251046 HEWPACK  
A,C,CM,E,M,P

Hewlett-Packard de Venezuela, C.A.  
Centro Ciudad Comercial Tamanaco  
Nivel C-2 (Nueva Etapa)  
Local 53H05  
Chuaq. **CARACAS**  
Tel: 928291  
P

Albis Venezolana S.R.L.  
Av. Las Marias, Ota. Alix,  
El Pedregal  
Apartado 81025  
**CARACAS 1080A**  
Tel: 747984, 742146  
Telex: 24009 ALBIS VC  
A

Tecnologica Medica del Caribe, C.A.  
Multicentro Empresarial del Este  
Ave. Libertador  
Edif. Libertador  
Nucleo "C" - Oficina 51-52  
**CARACAS**  
Tel: 339867/333780  
M

Hewlett-Packard de Venezuela C.A.  
Residencias Tia Betty Local 1  
Avenida 3 y con calle 75  
**MARACAIBO**, Estado Zulia  
Apartado 2646  
Tel: (061) 75801-75805-75806-  
80304  
Telex: 62464 HPMAR  
C,E\*

Hewlett-Packard de Venezuela C.A.  
Urb. Lomas de Este  
Torre Trebol — Piso 11  
**VALENCIA**, Estado Carabobo  
Apartado 3347  
Tel: (041) 222992/223024  
C,P

### YUGOSLAVIA

Do Hermes  
General Zdanova 4  
YU-11000 **BEOGRAD**  
Tel: 340 327, 342 641  
Telex: 11433  
A,C,E,P

Hermes  
Titova 50  
YU-61000 **LJUBLJANA**  
Tel: 324 856, 324 858  
Telex: 31583  
C,E,M,P

Elektrotehna  
Titova 51  
YU-61000 **LJUBLJANA**  
CM

### ZAIRE

Computer & Industrial Engineering  
25, Avenue de la Justice  
B.P. 12797  
**KINSHASA**, Gombe  
Tel: 32063  
Telex: 21552  
C,P

### ZAMBIA

R.J. Tilbury (Zambia) Ltd.  
P.O. Box 32792  
**LUSAKA**  
Tel: 215590  
Telex: 40128  
E

### ZIMBABWE

Field Technical Sales (Private) Limited  
45, Kelvin Road North  
P.O. Box 3458  
**HARARE**  
Tel: 705 231  
Telex: 4-122 RH  
E,P